

OWNER'S MANUAL

SYLVANIA

19-INCH COLOR TV/DVD/VHS SSC719B1

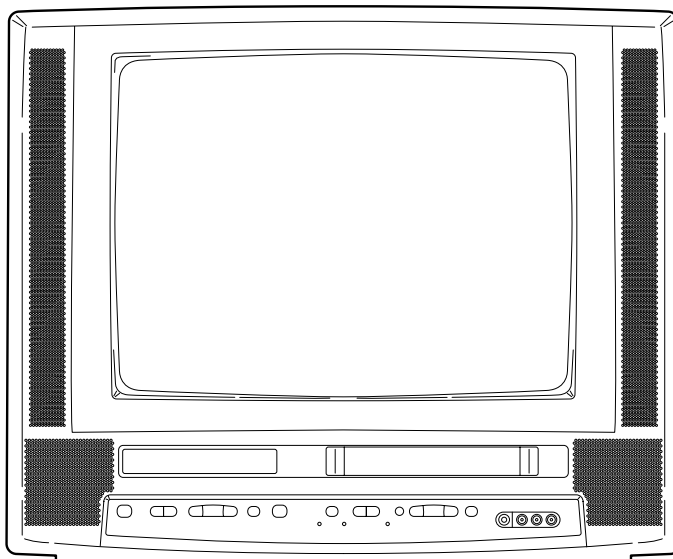

TruSurround™
by **SRS (S)**

This Owner's Manual is
made of recycled paper.

INSTRUCCIONES EN ESPAÑOL INCLUIDAS.

SUPPLIED ACCESSORIES

| ACCESSORIES | PART NO. |
|---------------------|----------------|
| Remote Control Unit | N0288UD |
| Batteries | 2 AA Batteries |

If you need additional operating assistance after reading this owner's manual or to order replacement accessories, please call
TOLL FREE : 1-800-968-3429.



Please read before using this equipment

WARNING: TO REDUCE THE RISK OF FIRE OR ELECTRIC SHOCK, DO NOT EXPOSE THIS APPLIANCE TO RAIN OR MOISTURE.



CAUTION

**RISK OF ELECTRIC SHOCK
DO NOT OPEN**



CAUTION: TO REDUCE THE RISK OF ELECTRIC SHOCK, DO NOT REMOVE COVER (OR BACK). NO USER SERVICEABLE PARTS INSIDE. REFER SERVICING TO QUALIFIED SERVICE PERSONNEL.



THIS SYMBOL INDICATES THAT DANGEROUS VOLTAGE CONSTITUTING A RISK OF ELECTRIC SHOCK IS PRESENT WITHIN THIS UNIT.



THIS SYMBOL INDICATES THAT THERE ARE IMPORTANT OPERATING AND MAINTENANCE INSTRUCTIONS IN THE LITERATURE ACCOMPANYING THE APPLIANCE.

The caution marking is located on the rear of the cabinet.

IMPORTANT SAFEGUARDS

- 1.Read instructions-**All the safety and operating instructions should be read before the appliance is operated.
- 2.Retain Instructions-**The safety and operating instructions should be retained for future reference.
- 3.Heed Warnings-**All warnings on the appliance and in the operating instructions should be adhered to.
- 4.Follow Instructions-**All operating and use instructions should be followed.
- 5.Cleaning-**Unplug TV/DVD/VHS from the wall outlet before cleaning. Do not use liquid cleaners or aerosol cleaners. Use a damp cloth for cleaning.
EXCEPTION: A product that is meant for uninterrupted service and, that for some specific reason, such as the possibility of the loss of an authorization code for a CATV converter, is not intended to be unplugged by the user for cleaning or any other purpose, may exclude the reference to unplugging the appliance in the cleaning description otherwise required in item 5.
- 6.Attachments-**Do not use attachments not recommended by the TV/DVD/VHS manufacturer as they may cause hazards.
- 7.Water and Moisture-**Do not use this TV/DVD/VHS near water—for example, near a bath tub, wash bowl, kitchen sink, or laundry tub, in a wet basement, or near a swimming pool, and the like.
- 8.Accessories-**Do not place this TV/DVD/VHS on an unstable cart, stand, tripod, bracket, or table. The TV/DVD/VHS may fall, causing serious injury to someone, and serious damage to the appliance. Use only with a cart, stand, tripod, bracket, or table recommended by the manufacturer, or sold with the TV/DVD/VHS. Any mounting of the appliance should follow the manufacturer's instructions and should use a mounting accessory recommended by the manufacturer. An appliance and cart combination should be moved with care. Quick stops, excessive force, and uneven surfaces may cause the appliance and cart combination to overturn.

PORTABLE CART WARNING



S3126A

AMEUBLES- Cet appareil ne doit être placé que sur un meuble (avec ou sans roulettes) recommandé par le fabricant. Si vous l'installez sur un meuble à roulettes, déplacez les deux ensembles avec précaution. Un arrêt brusque, l'utilisation d'une force excessive et des surfaces irrégulières risquent de déstabiliser l'ensemble et de le renverser.

SYMBÔLE D'AVERTISSEMENT POUR
LES COMPOSANTES
APPAREIL ET MEUBLE À ROULETTES



S3126A

- 9. Ventilation-**Slots and openings in the cabinet and the back or bottom are provided for ventilation and to ensure reliable operation of the TV/DVD/VHS and to protect it from overheating, and these openings must not be blocked or covered. The openings should never be blocked by placing the TV/DVD/VHS on a bed, sofa, rug, or other similar surface. This TV/DVD/VHS should never be placed near or over a radiator or heat register. This TV/DVD/VHS should not be placed in a built-in installation such as a bookcase or rack unless proper ventilation is provided or the manufacturer's instructions have been adhered to.
- 10.Power Sources-**This TV/DVD/VHS should be operated only from the type of power source indicated on the marking label. If you are not sure of the type of power supply to your home, consult your appliance dealer or local power company. For TV/DVD/VHSs intended to operate from battery power, or other sources, refer to the operating instructions.
- 11.Grounding or Polarization-**This TV/DVD/VHS is equipped with a polarized alternating-current line plug (a plug having one blade wider than the other). This plug will fit into the power outlet only one way. This is a safety feature. If you are unable to insert the plug fully into the outlet, try reversing the plug. If the plug should still fail to fit, contact your electrician to replace your obsolete outlet. Do not defeat the safety purpose of the polarized plug.
- 12.Power-Cord Protection-**Power-supply cords should be routed so that they are not likely to be walked on or pinched by items placed upon or against them, paying particular attention to cords at plugs, convenience receptacles, and the point where they exit from the appliance.

FIGURE A
EXAMPLE OF ANTENNA GROUNDING AS PER
NATIONAL ELECTRICAL CODE

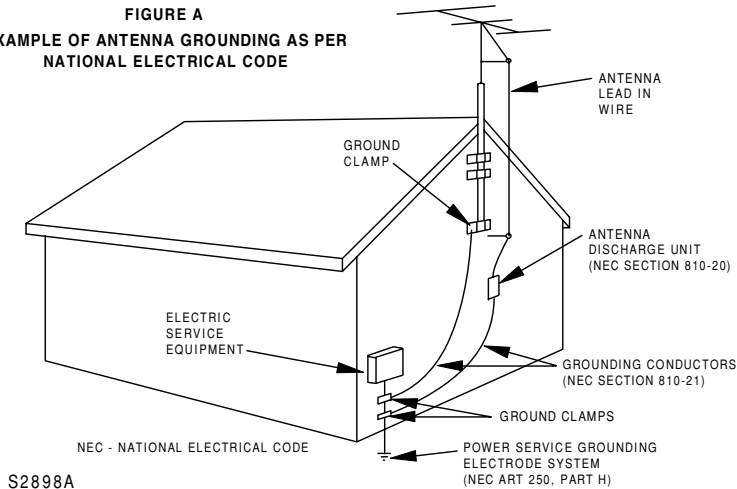

S2898A

13. Outdoor Antenna grounding-If an outside antenna or cable system is connected to the TV/DVD/VHS, be sure the antenna or cable system is grounded so as to provide some protection against voltage surges and built-up static charges. Article 810 of the National Electrical Code, ANSI/NFPA No. 70, provides information with respect to proper grounding of the mast and supporting structure, grounding of the lead-in wire to an antenna discharge unit, size of grounding conductors, location of antenna-discharge unit, connection to grounding electrodes, and requirements for the grounding electrode. (Fig. A)

14. Lightning-For added protection for this TV/DVD/VHS receiver during a lightning storm, or when it is left unattended and unused for long periods of time, unplug it from the wall outlet and disconnect the antenna or cable system. This will prevent damage to the TV/DVD/VHS due to lightning and power-line surges.

15. Power Lines-An outside antenna system should not be located in the vicinity of overhead power lines or other electric light or power circuits, or where it can fall into such power lines or circuits. When installing an outside antenna system, extreme care should be taken to keep from touching such power lines or circuits as contact with them might be fatal.

16. Overloading-Do not overload wall outlets and extension cords as this can result in a risk of fire or electric shock.

17. Object and Liquid Entry-Never push objects of any kind into this TV/DVD/VHS through openings as they may touch dangerous voltage points or short out parts that could result in a fire or electric shock. Never spill liquid of any kind on the TV/DVD/VHS.

18. Servicing-Do not attempt to service this TV/DVD/VHS yourself as opening or removing covers may expose you to dangerous voltage or other hazards. Refer all servicing to qualified service personnel.

19. Damage Requiring Service-Unplug this TV/DVD/VHS from the wall outlet and refer servicing to qualified service personnel under the following conditions:

- When the power-supply cord or plug is damaged or frayed.
- If liquid has been spilled, or objects have fallen into the TV/DVD/VHS.
- If the TV/DVD/VHS has been exposed to rain or water.
- If the TV/DVD/VHS does not operate normally by following the operating instructions. Adjust only those controls that are covered by the operating instructions, as improper adjustment of other controls may result in damage and will often require extensive work by a qualified technician to restore the TV/DVD/VHS to its normal operation.
- If the TV/DVD/VHS has been dropped or damaged in any way.
- When the TV/DVD/VHS exhibits a distinct change in performance-this indicates a need for service.

20. Replacement Parts-When replacement parts are required, be sure the service technician has used replacement parts specified by the manufacturer that have the same characteristics as the original part. Unauthorized substitutions may result in fire, electric shock, injury to persons or other hazards.

21. Safety Check-Upon completion of any service or repairs to this TV/DVD/VHS, ask the service technician to perform routine safety checks to determine that the TV/DVD/VHS is in proper operating condition.

22. Heat-This TV/DVD/VHS product should be situated away from heat sources such as radiators, heat registers, stoves, or other products (including amplifiers) that produce heat.

CAUTION: TO PREVENT ELECTRIC SHOCK, MATCH WIDE BLADE OF PLUG TO WIDE SLOT, FULLY INSERT.

ATTENTION: POUR ÉVITER LES CHOC ÉLECTRIQUES, INTRODUIRE LA LAME LA PLUS LARGE DE LA FICHE DANS LA BORNE CORRESPONDANTE DE LA PRISE ET POUSSER JUSQU'AU FOND.

PRECAUTIONS

IMPORTANT COPYRIGHT INFORMATION

Unauthorized copying, broadcasting, public performance and lending of discs are prohibited.

FCC WARNING- This equipment may generate or use radio frequency energy. Changes or modifications to this equipment may cause harmful interference unless the modifications are expressly approved in the instruction manual. The user could lose the authority to operate this equipment if an unauthorized change or modification is made.

RADIO-TV INTERFERENCE

This equipment has been tested and found to comply with the limits for a Class B digital device, pursuant to Part 15 of the FCC Rules. These limits are designed to provide reasonable protection against harmful interference in a residential installation.

This equipment generates, uses, and can radiate radio frequency energy and, if not installed and used in accordance with the instructions, may cause harmful interference to radio communications.

However, there is no guarantee that interference will not occur in a particular installation. If this equipment does cause harmful interference to radio or television reception, which can be determined by turning the equipment off and on, the user is encouraged to try to correct the interference by one or more of the following measures:

- 1) Reorient or relocate the receiving antenna.
- 2) Increase the separation between the equipment and receiver.
- 3) Connect the equipment into an outlet on a circuit different from that to which the receiver is connected.
- 4) Consult the dealer or an experienced radio/TV technician for help.

LASER SAFETY

This unit employs a laser. Only a qualified service person should remove the cover or attempt to service this device, due to possible eye injury.

CAUTION: USE OF CONTROLS OR ADJUSTMENTS OR PERFORMANCE OF PROCEDURES OTHER THAN THOSE SPECIFIED HEREIN MAY RESULT IN HAZARDOUS RADIATION EXPOSURE.

CAUTION: VISIBLE AND INVISIBLE LASER RADIATION WHEN OPEN AND INTERLOCK DEFEATED. DO NOT STARE INTO BEAM.

LOCATION: INSIDE, NEAR THE DECK MECHANISM.

This Class B digital apparatus complies with Canadian ICES-003.

Cet appareil numérique de la classe B est conforme à la norme NMB-003 du Canada.

CAUTION: TO PREVENT ELECTRIC SHOCK, MATCH WIDE BLADE OF PLUG TO WIDE SLOT, FULLY INSERT.

ATTENTION: POUR ÉVITER LES CHOC ÉLECTRIQUES, INTRODUIRE LA LAME LA PLUS LARGE DE LA FICHE DANS LA BORNE CORRESPONDANTE DE LA PRISE ET POUSSER JUSQU'AU FOND.

LOCATION

For safe operation and satisfactory performance of your TV/DVD/VHS, keep the following in mind when selecting a place for its installation:

- Shield it from direct sunlight and keep it away from sources of intense heat.
- Avoid dusty or humid places.
- Avoid places with insufficient ventilation for proper heat dissipation. Do not block the ventilation holes at the top and bottom of the unit. Do not place the unit on a carpet because this will block the ventilation holes.
- Install unit in a horizontal position.
- Avoid locations subject to strong vibration.
- Do not place the TV/DVD/VHS near strong magnetic fields.
- Avoid moving TV/DVD/VHS to locations where temperature differences are extreme.

AVOID THE HAZARDS OF ELECTRICAL SHOCK AND FIRE

- Do not handle the power cord with wet hands.
- Do not pull on the power cord when disconnecting it from an AC wall outlet. Grasp it by the plug.
- If, by accident, water is spilled on your unit, unplug the power cord immediately and take the unit to our Authorized Service Center for servicing.
- Do not put your fingers or objects into the TV/DVD/VHS disc loading tray.
- Do not place anything directly on top of the unit.

WARNING

Moisture condensation may occur inside the unit when it is moved from a cold place to a warm place, or after heating a cold room or under conditions of high humidity. If a DVD is played in a TV/DVD/VHS which has moisture, it may damage the DVD and TV/DVD/VHS. Therefore when the condensation occurs inside the unit, turn the POWER button on and allow at least 2 hours for the unit to dry out.

A NOTE ABOUT RECYCLING

This product's packaging materials are recyclable and can be reused. Please dispose of any materials in accordance with your local recycling regulations.

Batteries should never be thrown away or incinerated but disposed of in accordance with your local regulations concerning chemical wastes.

The serial number of this product may be found on the back of the unit. No other TV/DVD/VHS has the same serial number as yours. You should record the number and other vital information here and retain this book as a permanent record of your purchase to aid identification in case of theft. Serial numbers are not kept on file.

| | |
|----------------------|--|
| Date of Purchase | |
| Dealer Purchase from | |
| Dealer Address | |
| Dealer Phone No. | |
| Model No. | |
| Serial No. | |

TABLE OF CONTENTS

| | | | | | |
|---|----|---|----|--|------------|
| ■ IMPORTANT SAFEGUARDS | 2 | TRACKING ADJUSTMENT | 26 | DVD SECTION | |
| ■ PRECAUTIONS | 4 | SLOW MOTION | 26 | ■ ABOUT THE DISCS | 36 |
| LOCATION | 5 | PICTURE SEARCH | 26 | PLAYABLE DISCS | 36 |
| AVOID THE HAZARDS OF | | STILL PICTURE | 26 | DISC TYPES | 36 |
| ELECTRICAL SHOCK AND FIRE . | 5 | VERTICAL HOLD CONTROL | 26 | SYMBOLS USED IN | |
| WARNING | 5 | ■ SPECIAL PLAYBACK | 27 | THIS MANUAL | 36 |
| ■ FEATURES | 7 | RENTAL PLAYBACK | 27 | ■ PLAYING A DISC | 37 |
| ■ OPERATING CONTROLS AND | | AUTO REPEAT PLAYBACK | 27 | PLAYING A DVD VIDEO OR AN | |
| FUNCTIONS | 9 | ■ SEARCH | 28 | AUDIO CD | 36 |
| ■ PREPARATION FOR USE | 11 | ZERO RETURN | 28 | USING THE DVD MENUS | 36 |
| ANTENNA/CABLE | | TIME SEARCH | 28 | USING THE TITLE MENU | 36 |
| CONNECTIONS | 11 | INDEX SEARCH | 29 | RESUMING PLAYBACK | |
| CONNECTING TO EXTERNAL | | ■ SPECIAL FEATURES | 29 | FROM THE POINT WHERE | |
| INPUT JACKS | 12 | REAL TIME TAPE COUNTER | 29 | PLAYBACK STOPPED | 38 |
| INSTALLING THE BATTERIES . | 12 | AUTO REWIND-EJECT | 29 | FAST FORWARD/REVERSE | 38 |
| EXTERNAL INPUT MODE | 12 | ■ RECORDING | 30 | PAUSING PLAYBACK OR DIS- | |
| CONNECTING TO A DOLBY | | NORMAL RECORDING | 30 | PLAYING | |
| DIGITAL DECODER, | | DURING | | A STILL PICTURE | 38 |
| DTS DECODER, OR MPEG | | RECORDING | 30 | STEPPING THROUGH FRAMES . | 38 |
| DECODER (for DVD) | 13 | OTR (One Touch Recording) | 31 | SLOW MOTION | 39 |
| CONNECTING TO A STEREO | | COPYING A VIDEO CASSETTE | | PLAYING FROM A DESIRED | |
| SYSTEM (for DVD) | 14 | (Requires a VCR or camcorder) | 31 | TITLE OR CHAPTER | 39 |
| CONNECTING TO AN AMPLIFIER | | ■ TIMER | 32 | STARTING FROM A DESIRED | |
| EQUIPPED WITH DIGITAL INPUT | | AUTOMATIC | | TIME COUNT | 39 |
| JACKS SUCH AS MD DECK OR | | TIMER RECORDING | 32 | STARTING FROM A DESIRED | |
| DAT DECK (for DVD) | 14 | TIMER PROGRAM EXTENSION . | 33 | TRACK | 39 |
| ■ SET UP FOR USE | 15 | HINTS FOR AUTOMATIC TIMER | | REPEAT | 40 |
| CHANNEL SET UP | | RECORDING | 34 | A-B REPEAT | 40 |
| FOR THE FIRST TIME | 15 | AUTO RETURN | 34 | PROGRAM (Audio CD) | 41 |
| DELETING (OR ADDING) | | SLEEP TIMER | 34 | RANDOM (Audio CD) | 41 |
| CHANNEL | 15 | ■ ON SCREEN DISPLAY | 35 | ZOOM PLAYBACK | 41 |
| CHANNEL SET UP AGAIN | 16 | ■ CABLE CHANNEL | | ■ SETTINGS | 42 |
| SELECTING THE LANGUAGE . | 16 | DESIGNATIONS | 35 | CHANGING THE AUDIO | |
| DAYLIGHT-SAVING TIME | 16 | | | LANGUAGE OR SOUND MODE . | 42 |
| CLOCK SET UP | | | | CHANGING THE SUBTITLE | |
| (AUTO / MANUAL) | 17 | | | LANGUAGE | 43 |
| TV/VCR SECTION | | | | CHANGING THE CAMERA | |
| ■ TV OPERATION | 19 | | | ANGLE (Multi-Angle Pictures) | 43 |
| WATCHING A TV PROGRAM | 19 | | | CHANGING THE ON-SCREEN | |
| DEGAUSSING | 19 | | | DISPLAY | 44 |
| PICTURE CONTROL | 19 | | | ■ CHANGING THE SETUP ITEMS . | 45 |
| CLOSED CAPTION SYSTEM | 20 | | | LANGUAGE SETTINGS | 45 |
| V-CHIP SET UP | 21 | | | VIDEO SETTINGS | 46 |
| ■ MTS(Multi-Channel Television | | | | AUDIO SETTINGS | 46 |
| sound)SYSTEM | 23 | | | PARENTAL LOCK | 47 |
| CHECKING THE SELECTED | | | | OTHER SETTINGS | 48 |
| MTS MODE | 23 | | | ■ LANGUAGE CODE LIST | 49 |
| MTS RECORDING/MONITOR | | | | ■ TROUBLESHOOTING GUIDE | 50 |
| MODE | 23 | | | ■ MAINTENANCE | 53 |
| SELECTING THE MTS SYSTEM . | 24 | | | DISC HANDLING | 53 |
| ■ VIDEO CASSETTE | 25 | | | ■ SPECIFICATIONS | 54 |
| ■ PLAYBACK | 26 | | | ■ WARRANTY | Back Cover |
| NORMAL PLAYBACK | 26 | | | | |

FEATURES

TV/VCR

- **Hi-Fi system**—The Hi-Fi stereo recording system offers you excellent sound quality with a dynamic range of 80dB, frequency response from 20Hz to 20kHz, and 0.005% wow and flutter.
- **Rotary 4-head Record/Playback System**—Four heads ensure excellent picture quality and special effects playback.
- **Index Search**—Fast-forwards to start of next recording.
- **Slow Motion**—View recorded program at slower than normal speed.
- **Infrared remote control**
- **Trilingual on screen tv/vcr setup display selectable in English or Spanish or French**
- **Real time counter**—This shows the elapsed recording or playback time in hours, minutes, and seconds. The “_” indication will appear when the tape is rewound further than the tape counter position “0:00:00”.
- **181 channel capability PLL frequency synthesizer tuner with direct station call**—(A converter may be necessary to view scrambled cable channels.)
- **Auto Clock Setting**—Allows you to set the clock function from a PBS broadcast station.
- **Closed caption system**—You may view specially labeled (cc) TV programs, movies, news, prerecorded tapes, etc. with either a dialogue caption or text display added to the program.
- **Auto power on and off system**—Automatically turns on the TV/DVD/VHS when you insert the cassette, turns off after auto-rewind, and ejects when the beginning of the tape is reached.
- **Auto rewind when the end of a tape is reached**—This function doesn’t occur when using timer recording.
- **2 Step picture search operation**—You can view a video program at a high speed or super high speed in either a forward or reverse direction in LP and SLP mode. For SP mode only high speed.
- **Three different playback tape speeds : SP/LP/SLP**
- **Two different recording tape speeds : SP/SLP**
- **Auto Head Cleaner**—Automatically cleans video heads as you insert or remove a cassette.
- **Zero Return**—The tape returns to counter of 0:00:00 by rewinding or fast forwarding.
- **Still**—“Freeze” the picture at any time, for close viewing of a particular scene.
- **Digital Auto Tracking (DTR)**—Automatically adjusts the tracking for each tape you play.
- **Rental play mode**—Improves playback picture quality from worn tapes, such as rental tapes.
- **Auto repeat**—Allows you to repeat the playing of a tape indefinitely without pressing the PLAY button.
- **Time search**—Let you set the TV/DVD/VHS to advance the tape by entering the desired playback time you want to skip.
- **OTR (One Touch Recording)**—Instant timed recording from 30 to 480 minutes is possible at the push of the REC/OTR button.
- **1 Year, 8 events (including Daily and Weekly Timer Recording)**—The built-in timer allows you to record up to 8 programs at different times on different channels up to 1 year in advance. The Daily timer allows recordings to be made of daily broadcasts, and the Weekly timer allows recording to be made once a week up to the end of the tape.
- **Auto return**—After timer recording is finished, the TV/DVD/VHS can return to the beginning of the recording.
- **Sleep timer**—Allows you to have the TV/DVD/VHS automatically turn on or off at a desired time. (This feature is not available for DVD mode.)
 - **Timer Program Extension**—Allow you to shift the time schedule for automatic timer recording.
- **V-CHIP**—Enables parents to prevent their children from watching inappropriate material on TV.

A NOTE ABOUT RECYCLING

This product’s packaging materials are recyclable and can be reused. Please dispose of any materials in accordance with your local recycling regulations.

Batteries should never be thrown away or incinerated but disposed of in accordance with your local regulations concerning chemical wastes.

DVD

- **Dolby Digital sound**

This player can handle Dolby Digital surround sound having 5.1 channels when connected to a Dolby Digital decoder.

- **Still/fast/slow/step playback**

Various playback modes are available including still pictures, fast forward/reverse, slow motion and step frames.

- **Random playback for audio CD**

This player can shuffle the order of tracks to play them in random order.

- **Program playback for audio CD**

You can program the order of tracks to play them in any desired order.

- **DVD menus in a desired language**

You can display DVD menus in a desired language, if available on a DVD.

- **Screen saver/Auto power-off functions**

The screen saver program starts when there is no input from the player for five minutes in the stop mode. When the screen saver program is activated for 30 minutes, the DVD power is automatically turned off, and "DVD" appears on the screen.

- **Subtitles in a desired language**

You can select a desired language for the display subtitles, if that language is available on a disc.

- **Selecting a camera angle**

You can select the desired camera angle, if a disc contains sequences recorded from different angles.

- **Choices for audio language and sound mode**

You can select the desired audio language and sound mode, if different languages and modes are available on a disc.

- **Parental lock**

You can set the control level to limit playback of discs which may not be suitable for children.

- **Automatic detection of discs**

This player automatically detects if a loaded disc is DVD or audio CD.

- **On-screen display**

Information about the current operation can be displayed on a TV screen, allowing you to confirm the currently active functions (such as program playback), on the TV screen using the remote control.

- **DTS (Digital Theater System)**

Sound system different from Dolby Digital sound system

- **Search**

Chapter search: Search for the chapter designated by user is possible.

Title search: Search for the title designated by user is possible.

Track search: Search for the track designated by user is possible.

Time search: Search for the time designated by user is possible.

- **Repeat**

Chapter: Repeated playback of the chapter of the disc being played is possible.

Title: Repeated playback of the title of the disc being played is possible.

Track: Repeated playback of the track of the disc being played is possible.

Disc(audio CD): Repeated playback of the entire disc being played is possible.

A-B: The part between A and B designated by user is possible.

- **Zoom**

4-time magnified screen can be displayed.

- **Marker**

The part designated by user can be called back.

- **Resume Play**

User can resume to playback from the part at which the play was stopped.

- **SRS TruSurround**

You can enjoy stereophonic virtual space on your existing stereo system.

- **Dimmer**

Brightness of the display can be varied.

- **Bit rate indication**

- **Dynamic range control**

This unit employs TruSurround system

TruSurround
by **SRS** (●) of SRS Labs, Inc. as virtual technology.

TruSurround and the (●)® symbol are trademarks of SRS Labs, Inc.

TruSurround technology is incorporated under license from SRS Labs, Inc.

NOTE:

- We do not recommend the use of universal remote controls. Not all of the functions may be controlled with a universal remote control.

If you decide to use a universal remote control with this unit, please be aware that the code number given may not operate this unit. In this case, please call the manufacturer of the universal remote control.

OPERATING CONTROLS AND FUNCTIONS

- TV/DVD/VHS FRONT PANEL - [Fig.1]

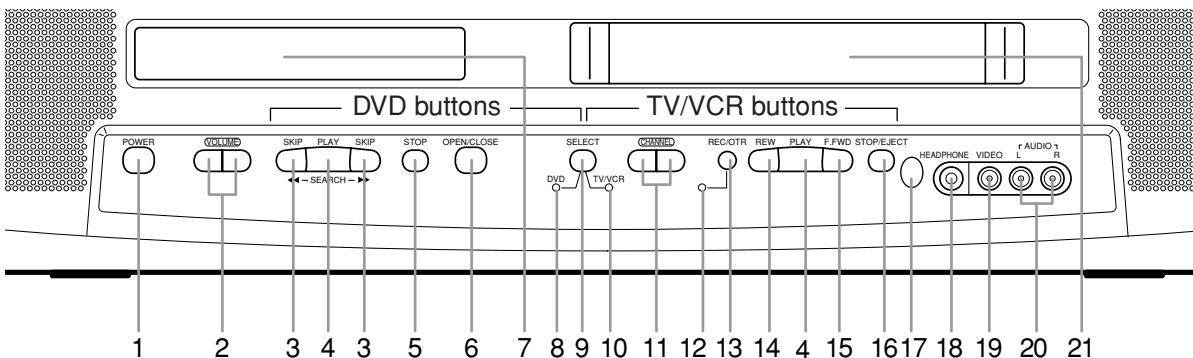

- REMOTE CONTROL - [Fig. 2]

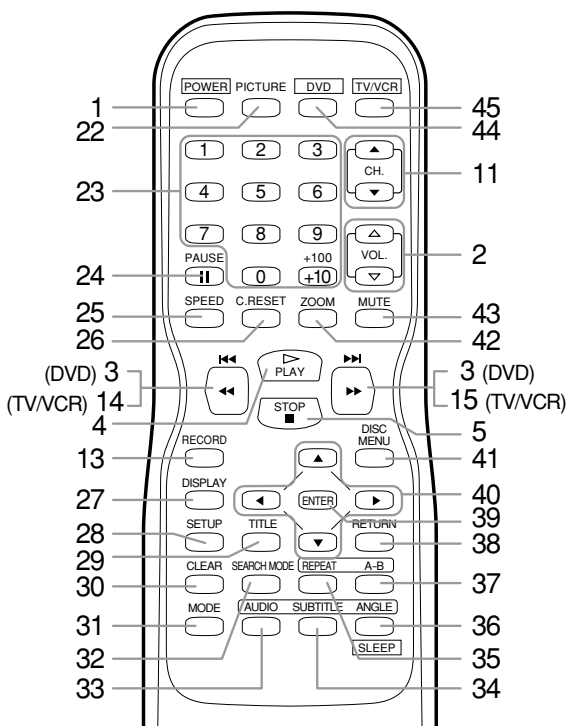

1. POWER button

Press to turn the power on and off.

2. VOLUME ▲/▼ buttons

Press to control the volume level for the DVD and TV.

3. SKIP buttons (for DVD)

Skip chapters or tracks to a desired point.

Press and hold in a second or more to get the function of fast forward or fast reverse.

4. PLAY button

Starts playback of the disc or tape contents.

5. STOP button(Front panel)

Stops operation of the disc.

STOP button(Remote Control)

Stops operation of the disc or the tape.

6. OPEN/CLOSE button

Press to insert discs into or remove them from the tray.

7. Disc loading tray

8. DVD indicator

Lights on during DVD mode.

9. SELECT button

Press to change to TV/VCR mode or DVD mode.

NOTE: For about 4 seconds just after the DVD mode has switched to the TV mode, the button does not work to switch back to the DVD mode.

10. TV/VCR indicator

Lights on during TV/VCR mode.

11. CHANNEL ▲/▼ buttons

Press to select memorized channel.

12. Recording indicator

Flashes during recording. Lights up in the Stand-by mode for Timer Recording.

13. REC/OTR (RECORD) button

Press for manual recording. Activates One Touch Recording. (OTR is only during TV/VCR mode.)

14. REW button (for TV/VCR)

Press to rewind the tape, or to view the picture rapidly in reverse during playback mode. (Rewind Search)

15. FWD button (for TV/VCR)

Press to rapidly advance the tape, or to view the picture rapidly in forward during playback mode. (Forward Search)

16. STOP/EJECT button

Press to stop the tape motion. Press in the Stop mode to remove tape from the unit.

17. Remote sensor window

18. HEADPHONE jack

To connect headphone (not supplied) for personal listening.

19. VIDEO input jack

Connect to the video output jack of a video camera or VCR.

- TV/DVD/VHS REAR PANEL - [Fig.3]

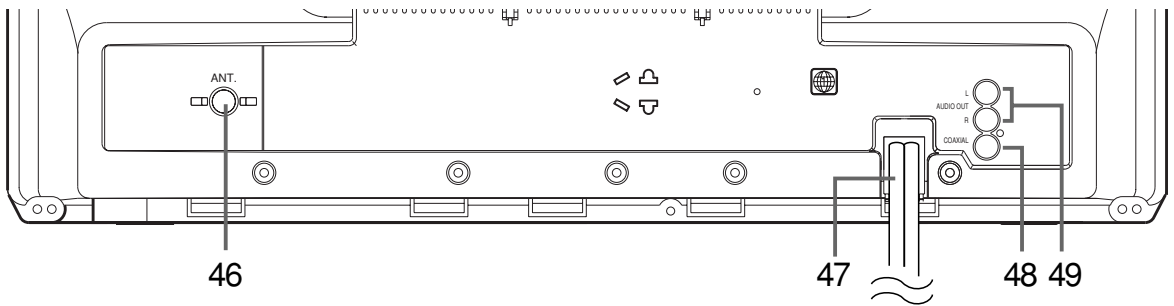

20. AUDIO L/R input jacks

Connect to the audio output jacks of a video camera or VCR.

21. Cassette compartment

22. PICTURE button

Press to adjust the picture.

23. Number buttons

TV Mode:

Press two digits to directly access the desired channel.

Remember to press a "0" before a single digit channel.

+100 button-

Press to select cable channels which are equal or greater than number 100.

DVD Mode:

Press to enter the desired number.

+10 button-

Press to enter the desired numbers which are equal or greater than number 10.

24. PAUSE button

Pauses the current disc or tape operation.

25. SPEED button

Press to choose the desired recording speed: SP/SLP.

26. C.RESET button

Press to reset counter to 0:00:00.

Press to cancel a setting of timer program. (See page 33.)

27. DISPLAY button

TV/VCR Mode:

Display the counter or the current channel number and current time on the TV screen.

DVD Mode:

Displays the current status on the TV screen for checking purposes.

28. SETUP button

Press to enter or exit the TV menu or DVD setup mode.

29. TITLE button

Displays the title menu.

30. CLEAR button

Resets a setting.

31. MODE button

Activates program playback or random playback mode.

32. SEARCH MODE button

Press to locate a desired point.

33. AUDIO button

Press to select a desired audio language or sound mode.

34. SUBTITLE button

Press to select a desired subtitle language.

35. REPEAT button

Repeats playback of the current disc, title, chapter or track.

36. ANGLE button (DVD mode)

Press to change the camera angle to see the sequence being played back from a different angle.

SLEEP button (TV/VCR mode)

Sets the Sleep Timer. (See page 34.)

37. A-B REPEAT button

Repeats playback of a selected section.

38. RETURN button

Returns to the previous operation.

39. ENTER button

Press to accept a setting.

40. Arrow buttons

TV/VCR Mode:

Press to select a setting mode from the menu on the TV screen.

Press to select or adjust from a particular menu.

DVD Mode:

Use when making settings while watching the display on a TV screen.

41. DISC MENU button

Displays the menus in the DVD.

42. ZOOM Button

Enlarges part of a DVD-reproduced image.

43. MUTE button

Mutes the sound. Press it again to resume sound.

44. DVD button

Press to switch to DVD mode. DVD indicator on the front will light on.

45. TV/VCR button

Press to switch to TV/VCR mode. TV/VCR indicator on the front will light on.

46. ANT. in jack

Connect to an antenna, cable system, or satellite system.

47. Power cord

Connect to a standard AC outlet (120V/60Hz).

NOTE: Remove the power cord from the hook to avoid breaking a wire before you connect to a standard AC outlet.

48. COAXIAL digital audio out jack

Connect to the digital input of an external amplifier or decoder.

49. AUDIO L/R output jack

Connect to the analog audio input of an external amplifier or decoder.

PREPARATION FOR USE

ANTENNA/CABLE CONNECTION

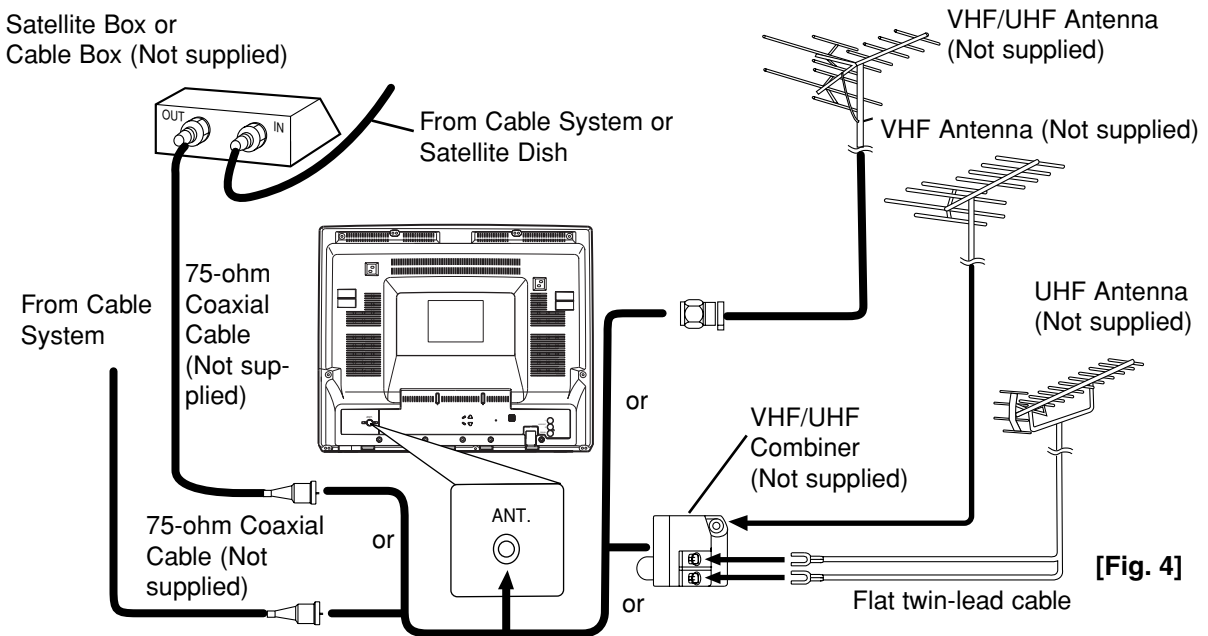

VHF/UHF SEPARATE ANTENNAS

In some areas it will be necessary to use an outdoor antenna.

CABLE WITHOUT CONVERTER/DESCRAMBLER BOX

Use this connection if your cable system connects directly to your TV/DVD/VHS without a converter box.

By using this connection you can:

- 1) Use the TV/DVD/VHS remote to select channels.
- 2) Program one or more unscrambled channels for Automatic Timer Recording.

NOTE: This unit will ONLY record and view the same channel.

CABLE WITH CONVERTER/DESCRAMBLER BOX OR SATELLITE BOX

If your cable service supplies you with a converter box or if you use a satellite system, you can use the basic connection shown in the illustration.

By using this connection you can also record scrambled channels. However, channel selection must be made with the converter box or satellite box. This means that channels cannot be changed using the TV/DVD/VHS Remote Control. Unattended timer recording is limited to one channel at a time.

**Antenna/Cable Connections
Continued on the Next Page.**

TO RECORD A SCRAMBLED/UNSCRAMBLED CHANNEL

1. Set the TV/DVD/VHS channel selector to the output channel of the Cable Converter Box or Satellite Box. (Ex. CH3)
2. Select the channel to record from your Cable Converter Box or Satellite Box.

Note to CATV system installer:

This reminder is provided to call the CATV system installer's attention to Article 820-40 of the NEC that provides guidelines for proper grounding and, in particular, specifies that the cable ground shall be connected to the grounding system of the building as close to the point of cable entry as practical.

CONNECTING TO EXTERNAL INPUT JACKS

When you watch a program recorded on an another source (VCR or video camera), use the audio/video input jacks on the front of the TV/DVD/VHS.

Connect the audio/video output jacks of another source to the AUDIO L/R and VIDEO jacks of this TV/DVD/VHS.

Then press the SELECT button until "VIDEO" appears on the screen.

NOTE:

- When you connect a monaural VCR (another source) to this TV/DVD/VHS, connect the Audio output jack of the monaural VCR (another source) to the AUDIO L jack of this TV/DVD/VHS. The audio will output in both L and R channel equally.

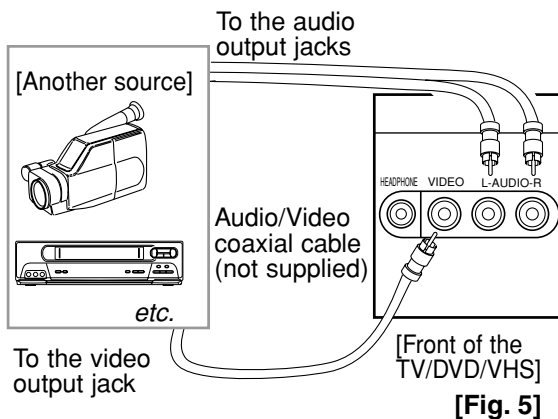

INSTALLING THE BATTERIES

- 1) Open the battery compartment cover by pressing the cover on the remote unit in the direction of the arrow.
- 2) Insert 2 "AA" penlight batteries into the battery compartment in the direction indicated by the polarity (+/-) markings.
- 3) Replace the cover.

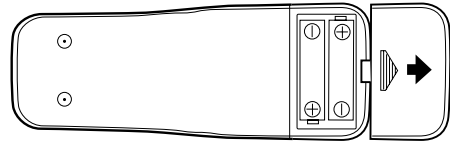

EXTERNAL INPUT MODE

When using an external input signal (another VCR or video camera), connect the player's audio/video output cables to the AUDIO L/R IN/ VIDEO IN jacks of your TV/DVD/VHS. Then press the CHANNEL ▲ or ▼ button until "AUX" appears on the screen.



CONNECTING TO A DOLBY DIGITAL DECODER, DTS DECODER, OR MPEG DECODER (for DVD)

If using this TV/DVD/VHS to play back a TV/DVD/VHS in a 5.1 channel Dolby Digital surround, DTS surround, or MPEG surround format, the TV/DVD/VHS outputs a Dolby Digital, DTS, or MPEG data stream from its COAXIAL DIGITAL AUDIO OUT jack. By hooking the player up to a Dolby Digital or DTS decoder, you can enjoy a more convincing, realistic ambience with powerful and high-quality surround sound of a professional standard such as can be heard in movie theaters.

Use audio coaxial digital cables (commercially available) for the audio connections.

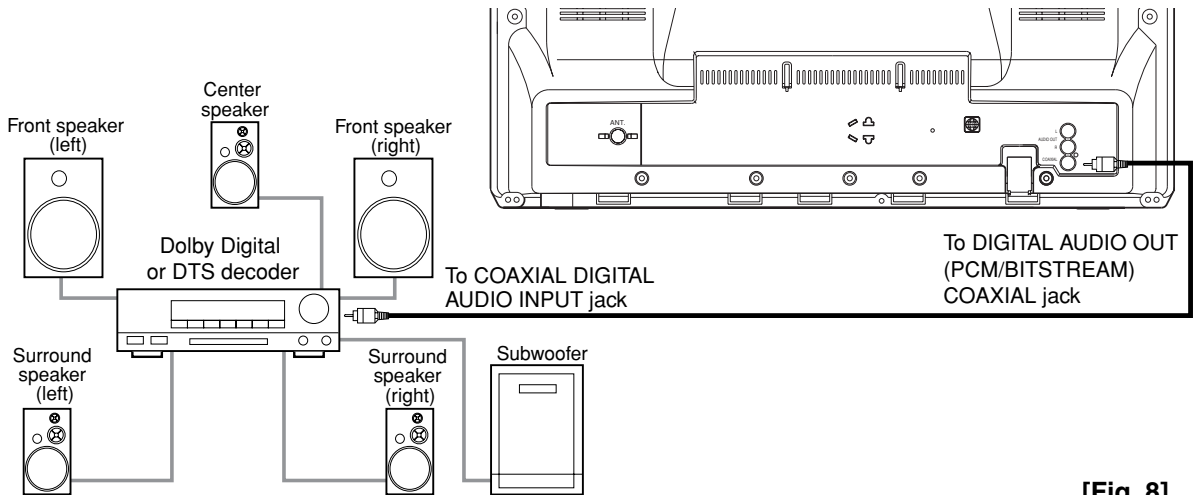

[Fig. 8]

NOTES:

- Be sure to turn off the power to all components in the system before connecting another component.
- Refer to the Owner's Manuals for the components to be connected to the TV/DVD/VHS.
- If output Dolby Digital audio, connect to a Dolby Digital decoder, and set Dolby Digital to on for audio output in the setup mode.
- If output DTS audio, connect to a DTS decoder, and set DTS to ON for audio output in the setup mode.
- If played a disc indicated MPEG audio, connect to a MPEG decoder, and set MPEG to ON for audio output in the setup mode.
- Unless connected to a Dolby Digital decoder, a DTS decoder, or a MPEG decoder, set Dolby Digital, DTS, or MPEG to off for audio output in the setup mode. Playing a TV/DVD/VHS using incorrect settings may generate noise distortion, and may also damage the speakers.
- When DOLBY DIGITAL is set to OFF and VIRTUAL 3D to ON for audio output in the setup mode and you select the audio source in a 5.1 channel Dolby Digital surround format, the audio will be muted.

Manufactured under license from Dolby Laboratories. "Dolby" and the double-D symbol are trademarks of Dolby Laboratories.

"DTS" and "DTS Digital Out" are trademarks of Digital Theater Systems Inc.

CONNECTING TO A STEREO SYSTEM (for DVD)

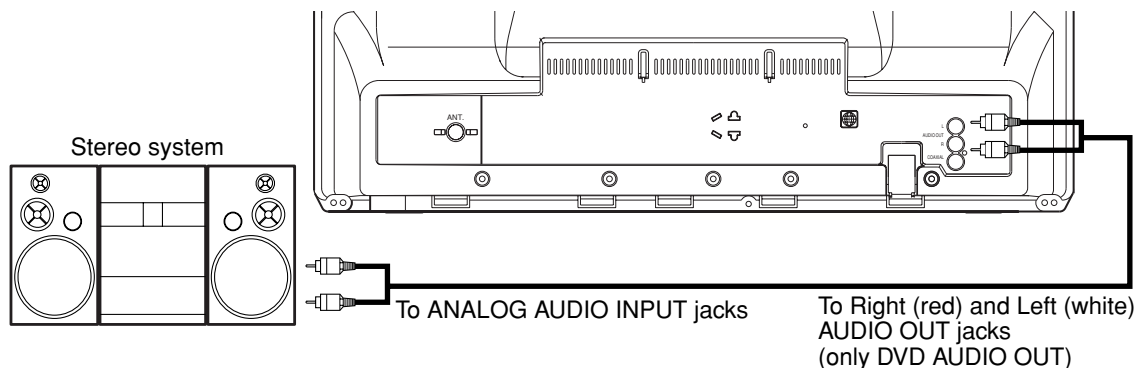

[Fig. 6]

NOTES:

- Be sure to turn off the power to all components in the system before connecting another component.
- Refer to the Owner's Manuals for your, stereo system and any other components to be connected to the TV/DVD/VHS.

CONNECTING TO AN AMPLIFIER EQUIPPED WITH DIGITAL INPUT JACKS SUCH AS MD DECK OR DAT DECK (for DVD)

Use an audio coaxial digital cable (commercially available) for the audio connections.

Connecting to an amplifier equipped with digital input jacks such as MD Deck or Dat Deck.

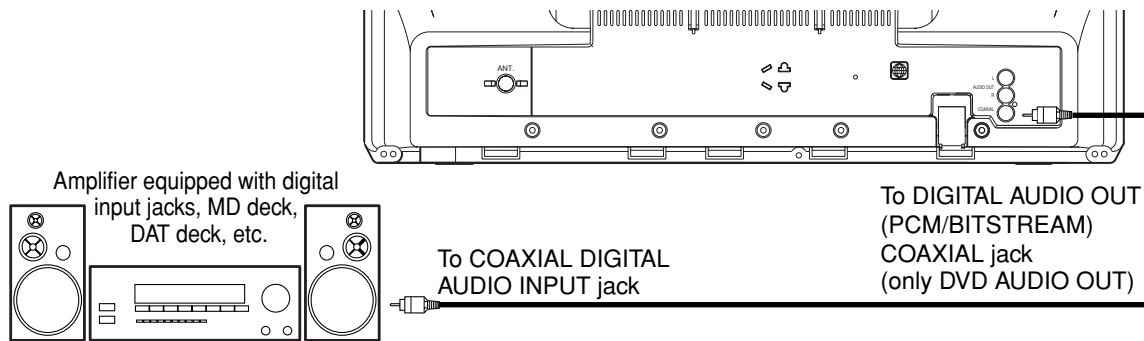

[Fig. 7]

NOTES:

- The audio source on a disc in a 5.1 channel Dolby Digital surround format cannot be recorded as digital sound by an MD or DAT deck.
- Be sure to turn off the power to all components in the system before connecting another component.
- Refer to the Owner's Manuals for the components to be connected to the TV/DVD/VHS.
- Set DOLBY DIGITAL and DTS to OFF for audio output in the setup mode. Playing a TV/DVD/VHS using incorrect settings may generate noise distortion, and may also damage the speakers.
- When DOLBY DIGITAL is set to OFF and VIRTUAL 3D to ON for audio output in the setup mode and you select the audio source in a 5.1 channel Dolby Digital surround format, the audio will be muted.

SET UP FOR USE

You can program the tuner to scan all the channels you receive in your area.

NOTE: Channel memory programming is NOT needed when connected to a cable box or satellite box. Just select the TV/DVD/VHS channel selector to the output channel of the cable box or satellite box (Ex CH3). Then select the channel to be viewed on the Cable Box or Satellite Box.

CHANNEL SET UP FOR THE FIRST TIME

1 Plug in the TV/DVD/VHS power cord

Plug the TV/DVD/VHS power cord into a standard AC outlet.

NOTE:

- If some digits appear in the corner of the screen, press the POWER button without unplugging the power cord.

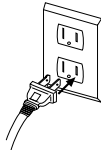

2 Turn on the TV/DVD/VHS

Press the POWER button to turn on the TV/DVD/VHS.

3 Select "ENGLISH" or "ESPAÑOL" or "FRANÇAIS"

Select "ENGLISH" or "ESPAÑOL"=Spanish or "FRANÇAIS" =French using the Arrow ► or ◀ button. "[]" indicate the selected language.

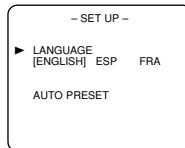

4 Begin auto preset

Press the Arrow ▲ or ▼ button to point to "AUTO PRESET".

Then press the Arrow ► button.

The tuner scans and memorizes all active channels in your area.

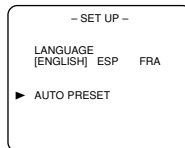

NOTES:

- The TV/DVD/VHS distinguishes between standard TV channels and cable channels.
- If you want to play or record a video tape BEFORE presetting the tuner, you must press the SETUP button on the remote control. To preset the tuner again, see "CHANNEL SET UP AGAIN" on page 15.
- The TV/DVD/VHS may memorize TV channels as CATV channels if reception conditions is poor. If this happens, try AUTO MEMO action again when reception conditions are better.

5 After scanning

The tuner stops on the lowest memorized channel.

If you want to recall the selected channels, you can select the desired channel directly with the remote control number buttons or CHANNEL ▲ or ▼.

DELETING (OR ADDING) CHANNEL

The channels you no longer receive or seldom watch can be deleted from the memory. (Of course, you can add the deleted channel into the memory again.)

1 Select "CHANNEL SET UP"

Press the SETUP button on the remote control.

Press the Arrow ▲ or ▼ button to point to "CHANNEL SET UP".

Then, press the Arrow ► button.

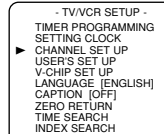

2 Select "ADD/DELETE CH"

Press the Arrow ▲ or ▼ button to point to "ADD/DELETE CH".

Press the Arrow ► button.

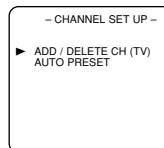

3 Enter the desired channel number

Press the Arrow ▲ or ▼ button until your desired channel number

appears. (You can also use the number buttons or the CHANNEL ▲/▼ button to enter it) (Example: CH8)

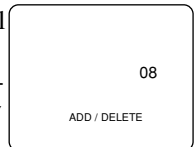

4 Delete (or add) it from (into) memory

Press the Arrow ► or ◀ button. The channel number changes to light red. The channel is deleted from memory.

- To delete another channel, repeat steps [3] and [4].
- If you press the Arrow ► or ◀ button again, the channel is memorized again.

5 Exit the channel setup mode

Added channel: Light blue.
Deleted channel: Light red.

Press the SETUP button on the remote control to returns to TV mode.

NOTE: To confirm that channel(s) has been deleted or added, press the CHANNEL ▲ or ▼ button.

CHANNEL SET UP AGAIN

Make sure ...

- Press the POWER button to turn on the TV/DVD/VHS.

1 Select "CHANNEL SET UP"

Press the SETUP button on the remote control.

Press the Arrow ▲ or ▼ button to point to "CHANNEL SET UP".

Then, press the Arrow ► button.

```
- TV/VCR SETUP -
TIMER PROGRAMMING
SETTING CLOCK
▶ CHANNEL SET UP
USER'S SET UP
V-CHIP SET UP
LANGUAGE [ENGLISH]
CAPTION [OFF]
ZERO RETURN
TIME SEARCH
INDEX SEARCH
```

2 Begin auto preset

Press the Arrow ▲ or ▼ button to point to "AUTO PRESET".

Then, press the Arrow ► button.

The tuner scans and memorizes all the active channels in your area.

```
- CHANNEL SET UP -
ADD / DELETE CH (TV)
▶ AUTO PRESET
```

3 After scanning

The tuner stops on the lowest memorized channel.

SELECTING THE LANGUAGE

Make sure ...

- Press the POWER button to turn on the TV/DVD/VHS.

NOTE: This function effects only the language on the screen menu and not the audio source.

1 Select "LANGUAGE"

Press the SETUP button on the remote control.

Press the Arrow ▲ or ▼ button to point to "LANGUAGE".

```
- TV/VCR SETUP -
TIMER PROGRAMMING
SETTING CLOCK
CHANNEL SET UP
USER'S SET UP
V-CHIP SET UP
▶ LANGUAGE [ENGLISH]
CAPTION [OFF]
ZERO RETURN
TIME SEARCH
INDEX SEARCH
```

2 Select "ENGLISH" or "ESPAÑOL" or "FRANÇAIS"

Select "ENGLISH" or "ESPAÑOL"= Spanish or "FRANÇAIS"= French using the Arrow ► or ◀ button.

3 Exit the Language mode

Press the SETUP button on the remote control to return to TV mode.

NOTE: If Spanish or French is selected accidentally, press the SETUP button on the remote control, press the Arrow ▲ button to point to "IDIOMA [ESPAÑOL]" or "LANGAGE" [FRANÇAIS], then press the Arrow ► button, then press the SETUP button on the remote control.

DAYLIGHT-SAVING TIME

Select this feature and the TV/DVD/VHS's clock automatically will advance one hour in April, then reverse one hour in October.

When Daylight-Saving Time is ON, the clock will change automatically as follows:

- **First Sunday of April** : At 2 AM the clock immediately changes to 3 AM. Any timer programming you have set to occur between 2 AM and 3 AM will not record.
- **Last Sunday of October** : At 2 AM the clock immediately changes to 1 AM.

Make sure ...

- Press the POWER button to turn on the TV/DVD/VHS.

1 Select "SETTING CLOCK"

Press the SETUP button on the remote control.

Press the Arrow ▲ or ▼ button to point to "SETTING CLOCK".

Then, press the Arrow ► button.

```
- TV/VCR SETUP -
TIMER PROGRAMMING
▶ SETTING CLOCK
CHANNEL SET UP
USER'S SET UP
V-CHIP SET UP
LANGUAGE [ENGLISH]
CAPTION [OFF]
ZERO RETURN
TIME SEARCH
INDEX SEARCH
```

2 Set "D.S.T." (Daylight-Saving Time) to [ON]

Press the Arrow ▲ or ▼ button to point to "D.S.T.".

Then, press the Arrow ► or ◀ button until [ON] appears.

```
- SETTING CLOCK -
AUTO CLOCK [ON]
AUTO CLOCK CH [AUTO]
MANUAL CLOCK SET
▶ D.S.T. [ON]
```

3 Exit the Daylight-Saving Time mode

Press the SETUP button on the remote control to return to TV mode.

TO CANCEL THE DAYLIGHT-SAVING TIME

Repeat steps [1] to [2], select [OFF] using the Arrow ► or ◀ button.

CLOCK SET UP (AUTO / MANUAL)

Set the clock accurately for proper automatic timer recording. If the Public Broadcasting Station (PBS) is available in your area, follow "AUTO CLOCK SETTING". If it is not, follow "MANUAL CLOCK SETTING".

AUTO CLOCK SETTING

You can have the TV/DVD/VHS set the clock automatically by using the Public Broadcasting Station (PBS) channel in your area. Once you have set the clock by using the following procedure, the TV/DVD/VHS will automatically monitor the correct time and date being broadcast by the PBS station in your area, using a new service called Extended Data Service (XDS).

Make sure ...

- TV/DVD/VHS power must be turned on.
- Confirm that the antenna connections are correct.
- The cable converter box must be turned on if your TV/DVD/VHS is connected directly to it. (See NOTES:)
- The channel is properly set in advance. (See page 16.)

NOTES:

- Auto clock setting only needs to be set once. But it can be done again if the clock's time has become incorrect for some reason.
- If the TV/DVD/VHS is connected directly to a cable converter box or satellite box, the local PBS station must be selected on the cable box itself, and the TV/DVD/VHS must be set to the output channel of the cable converter box or satellite box (usually channel 3 or 4), to be able to set up or correct the clock automatically.

If you do not know what your local PBS station is, then follow "Manual Clock Settings" on page 18. The TV/DVD/VHS cannot control the channels of the cable converter box or satellite box.

1 Select "SETTING CLOCK"

Press the SETUP button on the remote control.

Press the Arrow ▲ or ▼ button to point to "SETTING CLOCK".

Then, press the Arrow ► button.

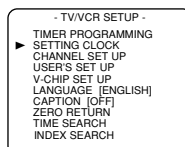

2 Set "AUTO CLOCK" to [ON]

Press the Arrow ► or ◀ button repeatedly until [ON] appears.

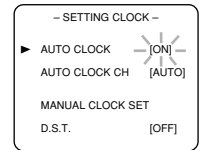

3 Enter the channel number for the PBS station

Press the Arrow ▲ or ▼ button to point to "AUTO CLOCK CH".

Then press the Arrow ► or ◀ button until the channel number for your local PBS station appears.

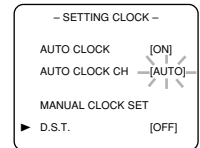

If you do not know the PBS channel number, leave it set to [AUTO] which is located before [2]. The TV/DVD/VHS will search automatically all available channels for the local PBS station, and will select that channel.

4 Exit the Auto Clock Setting

Press the SETUP button on the remote control to return to TV mode.

5 Turn off the TV/DVD/VHS

Turn the TV/DVD/VHS off. Because the Auto Clock functions automatically while the TV/DVD/VHS is off.

If you choose [AUTO],

- the TV/DVD/VHS must search until the PBS channel is found. It must scan each channel for a couple of seconds to determine if that channel is transmitting the XDS signal.
- if the time, that is automatically set by this selected PBS station is incorrect, it may not be your local PBS station, but one from a different time zone. Or there is a case that no channel is broadcasting the XDS signal in your area, as shown by no time. In these cases, you must manually enter the correct local PBS station, or set the clock manually and turn off the Auto Clock Setting feature.

MANUAL CLOCK SETTING

Make sure ...

- TV/DVD/VHS power must be turned on.

1 Select "SETTING CLOCK"

Press the SETUP button on the remote control.

Press the Arrow ▲ or ▼ button to point to "SETTING CLOCK".

Then, press the Arrow ► button.

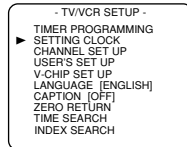

2 Select "MANUAL CLOCK SET"

Press the Arrow ▲ or ▼ button to point to "MANUAL CLOCK SET".

Then, press the Arrow ► button.

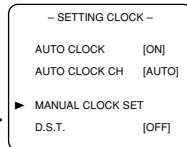

3 Select the month

Press the Arrow ▲ or ▼ button until your desired month appears.

(Example: May → 05)

Then, press the Arrow ► button.

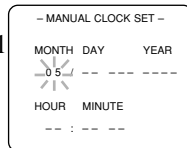

4 Select the day

Press the Arrow ▲ or ▼ button until your desired day appears.

(Example: 7th → 07)

Then, press the Arrow ► button.

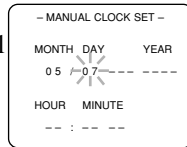

5 Select the year

Press the Arrow ▲ or ▼ button until your desired year appears.

(Example: 2002)

Then, press the Arrow ► button.

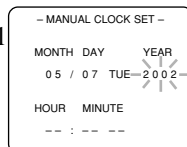

In the example below, the clock is to be set to:

DATE May 7th, 2002

SETTING TIME 5:40PM

6 Select the hour

Press the Arrow ▲ or ▼ button until your desired hour appears.

(Example: 5, PM)

Then, press the Arrow ► button.

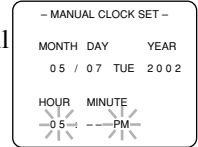

7 Select the minute

Press the Arrow ▲ or ▼ button until the desired minute appears.

(Example: 40)

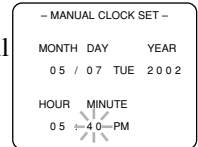

8 Start the clock

Press the SETUP button on the remote control.

Although seconds are not displayed, they begin counting from 00 when you press the SETUP button on the remote control. Use this feature to synchronize the clock with the correct time.

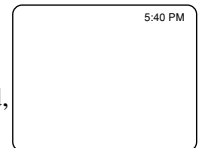

NOTE:

When unplugging the AC cord or if there is a power failure for more than 30 seconds, you may have to reset the clock.

TO CHANGE CLOCK SETTING

If you want to change the clock,

- 1) Follow steps [1] and [2].
- 2) Select where you want to change using the Arrow ► or ◀ button.
- 3) Enter correct numbers using the Arrow ▲ or ▼ button.
- 4) Press the SETUP button on the remote control to start the clock.

PLEASE NOTE:

If there is no local PBS station in your area or on your cable system, select "AUTO CLOCK" and press the Arrow ► or ◀ button to turn [OFF] this function. Then you can manually adjust the clock.

TV OPERATION

WATCHING A TV PROGRAM

1 Turn on the TV/DVD/VHS

Press the POWER button to turn on the TV/DVD/VHS.

2 Select the channel number

Press the CHANNEL ▲ or ▼ button to select your desired channel number or press the number buttons on the remote control.

Remember: If the TV/DVD/VHS is connected to a cable box or satellite box, the TV/DVD/VHS must be on CH3 or CH4, then the channel to be viewed must be selected on the cable box or satellite box.

3 Adjust sound

Press the VOLUME ▲ or ▼ button to adjust the volume.

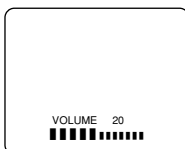

NOTES:

- If you press the CHANNEL ▲ or ▼ in the DVD mode, you can change the TV channels.
Even if you turn off the TV/DVD/VHS in the DVD mode, when you turn it on again, it will go into the TV/VCR mode.

DEGAUSSING

Magnetism from nearby appliances might affect the color of the TV picture.

If this happens, move this unit away from the appliance. If the color is still not correct, disconnect power cord from AC outlet then reconnect it after 30 minutes.

PICTURE CONTROL

The TV/DVD/VHS's picture controls – **BRIGHT, CONTRAST, COLOR, TINT** and **SHARPNESS** – are preset to factory specifications. Although they are usually the best, you may need to make some further adjustments for a natural looking image.

NOTES:

- Procedures must be followed within 5 seconds or the Picture Control mode will be cancelled.
- When setting the Picture Control, the Game mode will be cancelled.

Make sure ...

- TV/DVD/VHS power must be turned on.

1 Select "PICTURE CONTROL"

Press the PICTURE button on the remote control.

2 Select item you want to adjust

Press the Arrow ▲ or ▼ button until desired control is displayed.

BRIGHT
CONTRAST
COLOR
TINT
SHARPNESS

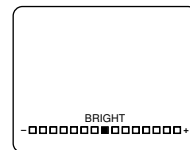

3 Adjust the picture control

Press the Arrow ► or ◀ button to adjust to your desired level.

| | Arrow ◀ | Arrow ► |
|------------------|------------------------|------------------------|
| BRIGHT | to decrease brightness | to increase brightness |
| CONTRAST | to decrease contrast | to increase contrast |
| COLOR | to pale | to brilliant |
| TINT | to purple | to green |
| SHARPNESS | to soft | to clear |

- If there is a power failure of any kind, the unit will retain its memory for this feature.

CLOSED CAPTION SYSTEM

You can view specially labeled (cc) TV programs, movies, news, pre-recorded tapes with either a dialogue caption or text display.

CAPTION mode: By choosing the caption mode, you can watch dramas, movies and news while captioning the dialogues and the contents of news.

TEXT mode: By choosing the text mode, you can watch half screen text information if you want.

1-2: You may get these captions or text information by selecting either "1" or "2". Caption "2" is used, usually for a second language if available.

NOTE:

Not all programs are broadcast with closed captions. Your television is designed to provide error free closed captions from high quality antenna, cable and VCR signals. Conversely, poor quality signals are likely to result in caption errors or no captions at all. Common signal conditions which may cause caption errors are listed below:

- Automobile ignition noise
- Electric motor brush noise
- Weak snowy reception on TV screen
- Multiplex signal reception displaying picture ghosts or airplane flutter.
- Playback of poorly recorded or worn VCR tapes.

NOTE:

If the TV/DVD/VHS displays a black box on the TV screen, this means that the TV/DVD/VHS is set to the TEXT mode. To clear screen, select [CAPTION1], [CAPTION2] or [OFF].



Make sure ...

- TV/DVD/VHS power must be turned on.

1 Select "CAPTION"

Press the SETUP button on the remote control.

Press the Arrow ▲ or ▼ button to point to "CAPTION".

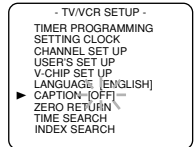

2 Select your desired caption menu

Press the Arrow ► or ◀ button until your desired caption menu appears.

([CAPTION1], [CAPTION2], [TEXT1] or [TEXT2])

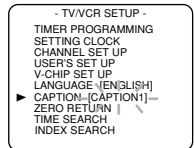

3 Exit the caption setting mode

Press the SETUP button on the remote control to return to TV mode.

TO CANCEL THE CLOSED CAPTION SYSTEM

Repeat steps [1] and [2], select [OFF] using the Arrow ► or ◀ button. Press the SETUP button on the remote control to return to TV mode.

WHEN THE CLOSED CAPTION MODE IS ON

The On-Screen Display will disappear after 5 seconds.

- This is also true when the MUTE button is pressed, and when the PAUSE button is pressed while recording.
- If there is a power failure of any kind, the unit will retain its memory for this feature.

V-CHIP SET UP

V-CHIP enables parents to prevent their children from watching inappropriate material on TV. V-CHIP reads the ratings for programming (except for news and sports programs, unedited movies on premium cable channels, and Emergency Broadcast System signals), then denies access to programming if the program's rating meets the limitations you select. In this case, "PROTECTED PROGRAM by ..." message appears on the TV screen. You can watch the protected program by entering access code (default 0000).

To block ratings, follow the steps below.

- Programming may be rated by the Motion Picture Association of America (MPAA) or according to the Television Parental Guidelines. In order to block any inappropriate programming, set your limits in both places (MPAA RATING and TV RATING).

TV RATING SET UP

Make sure ...

- TV/DVD/VHS power must be turned on.

1 Select "V-CHIP SET UP"

Press the SETUP button on the remote control.

Press the Arrow ▲ or ▼ button to point to "V-CHIP SET UP".

Then, press the Arrow ► button.

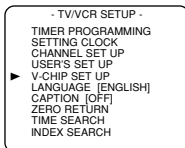

2 Input Access code

Use the number buttons to enter 4-digit access code. The default code is 0000.

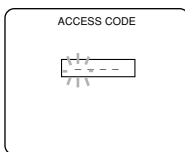

3 Select "TV RATING"

Press the Arrow ▲ or ▼ button to point to "TV RATING".

Then, press the Arrow ► button.

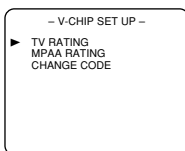

4 Select your desired item

Press the Arrow ▲ or ▼ button to point to your desired item.

Then, press the Arrow ► button to select [BLOCK] or [VIEW].

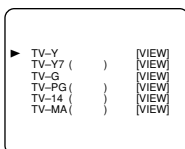

- When you select the rating category and turn it [BLOCK], the higher rating will turn [BLOCK] automatically. Also, the lower rating will turn [VIEW] automatically.
- When you turn "TV-Y" to [VIEW], the all ratings will turn to [VIEW] automatically.

| Selection | Rating Category Explanations |
|-----------|--|
| TV-Y | Appropriate for all children |
| TV-Y7 | Appropriate for children seven and older |
| TV-G | General Audience |
| TV-PG | Parental Guidance suggested. |
| TV-14 | Unsuitable for children under 14 |
| TV-MA | Mature audience only |

When you select TV-Y7, TV-PG, TV-14, or TV-MA and you press the Arrow ► button, the sub-ratings will appear on the TV screen.

If you select the rating category (example: TV-PG) and turn it [BLOCK] or [VIEW], the sub-ratings (example: V for Violence) will turn [BLOCK] or [VIEW] automatically.

You can set the sub-ratings to [BLOCK] or [VIEW] individually when the rating category is set to [BLOCK].

To set the sub-ratings individually, follow the steps below.

- When you select [TV-Y7]:**

Press the Arrow ▼ or ▲ button to select "FV" (Fantasy Violence). Then, press the Arrow ► button to select [BLOCK] or [VIEW].

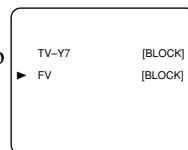

- When you select [TV-PG], [TV-14] or [TV-MA]:**

Press the Arrow ▼ or ▲ button to select "D" (Suggestive Dialog), "L" (Coarse Language), "S" (Sexual Situation), or "V" (Violence). Then, press the Arrow ► button to select [BLOCK] or [VIEW].

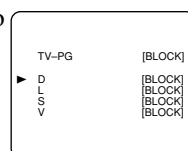

- Note:** When you select [TV-MA], "D" does not appear on the TV screen.

- The sub-ratings which set to [BLOCK] appears next to the rating category in the TV RATING menu.

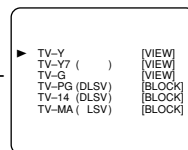

5 Exit the V-Chip setting mode

Press the SETUP button on the remote control to return to original mode.

MPAA RATING SET UP

Make sure ...

- TV/DVD/VHS power must be turned on.

1 Select "V-CHIP SET UP"

Press the SETUP button on the remote control.

Press the Arrow ▲ or ▼ button to point to "V-CHIP SET UP".

Then, press the Arrow ► button.

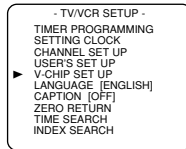

2

Use the number buttons to enter 4-digit access code. The default code is 0000.

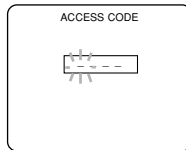

3 Select "MPAA RATING"

Press the Arrow ▲ or ▼ button to point to "MPAA RATING".

Then, press the Arrow ► button.

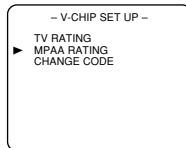

| Selection | Rating Category Explanations |
|-----------|---|
| G | General Audience |
| PG | Parental Guidance suggested. |
| PG-13 | Unsuitable for children under 13 |
| R | Restricted; under 17 requires accompanying parent or adult guardian |
| NC-17 | No one under 17 admitted |
| X | Mature audience only |

4 Select your desired item

Press the Arrow ▲ or ▼ button to point to your desired item.

Then, press the Arrow ► button to select [BLOCK] or [VIEW].

- When you select the rating category and turn it [BLOCK], the higher rating will turn [BLOCK] automatically. Also, the lower rating will turn [VIEW] automatically.
- When you turn "G" to [VIEW], the all ratings will turn to [VIEW] automatically.

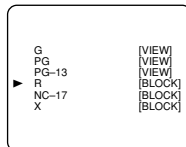

5 Exit the V-Chip setting mode

Press the SETUP button on the remote control to return to original mode.

CHANGE ACCESS CODE

To change access code, follow the steps.

1

Press the SETUP button so that the TV/VCR SETUP display appears on the TV screen.

2

Press the Arrow ▲ or ▼ button to point to "V-CHIP SET UP". Then, press the Arrow ► button.

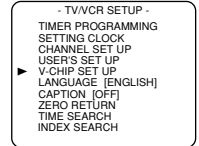

3

Use the number buttons to enter 4-digit access code. The default code is 0000.

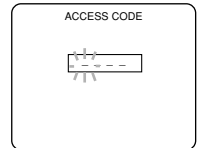

4

Press the Arrow ▲ or ▼ button to point to "CHANGE CODE". Then, press the Arrow ► button.

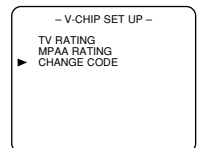

5

Use the number buttons to enter your desired access code in the NEW CODE space. Then enter the same code in the CONFIRM CODE space. V-CHIP SET UP screen appear on the screen.

- If you enter wrong code, repeat step 5, making sure you enter the same new code exactly in the confirm code space.

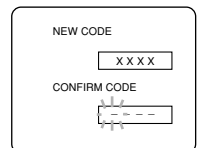
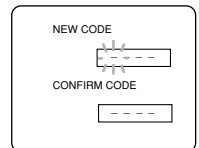

6

Press the SETUP button to exit the TV/VCR SETUP.

Note:

- If you unplug the power cord or power failure occurs, the changed access code will be lost and will return to default (0000). Change your access code again as necessary.

MTS(Multi-Channel Television sound)SYSTEM

You can record or listen to a program in MTS stereo.

CHECKING THE SELECTED MTS MODE

When you play a VHS tape, or receive a broadcast on the TV/DVD/VHS tuner channel you are watching, the status shown below will appear when you press the DISPLAY button on the remote control.

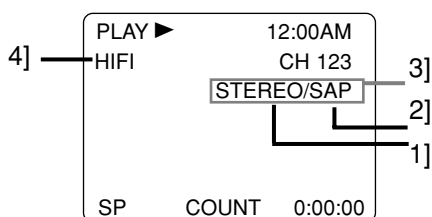

| | |
|-------------|---|
| SAP | Second Audio Program, which means your program, can also be received in a second language or sometimes a radio station. |
| HIFI | High Fidelity which produces better sound than standard stereo TV/DVD/VHSs. |

- 1] When a program is broadcast in stereo, STEREO appears on the TV screen.
- 2] When a program is broadcast in second audio, SAP appears on the TV screen.
- 3] When a program broadcast both in stereo and second audio, STEREO and SAP appear on the TV screen.

NOTE: Although a program may be broadcast in both stereo and second audio, you cannot record in both stereo and second audio at the same time.

- 4] While the TV/DVD/VHS is set in HIFI stereo mode and playback mode. HIFI appears on the TV screen. While the TV/DVD/VHS is set in monaural(MONO) mode, HIFI disappears from the TV screen.

NOTE: If you play non-HIFI tapes while the TV/DVD/VHS is set in HIFI, HIFI will disappear from the TV screen and the TV/DVD/VHS will play automatically in monaural.

MTS RECORDING/MONITOR MODE

| Type of broadcast | Display on the TV screen | STEREO/SAP SELECTION | Hi-Fi audio track(2-channel) | | Normal audio track |
|------------------------------|--------------------------|----------------------|------------------------------|--------------------|--------------------|
| | | | L-channel | R-channel | |
| Regular (monaural audio) | -None- | -Invalid- | Mono | Mono | Mono |
| Stereo broadcast | STEREO | -Invalid- | L | R | L+R |
| Bilingual broadcast | SAP | STEREO* | Main audio program | Main audio program | Main audio program |
| | | SAP* | Sub audio program | Sub audio program | Sub audio program |
| Stereo & Bilingual broadcast | STEREO SAP | STEREO* | L | R | L+R |
| | | SAP* | sub audio program | sub audio program | sub audio program |

*You must select the recording mode in TV AUDIO [STEREO] or [SAP] when you record a broadcast.

SELECTING THE MTS SYSTEM

Make sure ...

- TV/DVD/VHS power must be turned on.

TO SELECT HIFI MODE

1 Select "USER'S SET UP"

Press the SETUP button on the remote control.

Press the Arrow ▲ or ▼ button to point to "USER'S SET UP". Then, press the Arrow ► button.

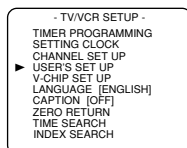

2 Select "VCR AUDIO"

Press the Arrow ▲ or ▼ button to point to "VCR AUDIO". Then, press the Arrow ► button.

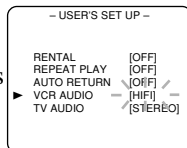

3 Select [HIFI]

Press the Arrow ► or ◀ button until [HIFI] appears.

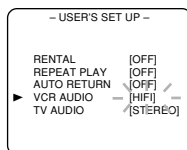

4 To return to TV mode

Press the SETUP button on the remote control to return to TV mode.

NOTES:

- Normally, "HIFI" should be selected for playback with HIFI sound.
- When you play non-HIFI tapes, the TV/DVD/VHS will play automatically in the monaural mode.
- The TV/DVD/VHS records automatically MTS broadcasts in HIFI stereo sound unless you select SAP mode recording before you begin recording.

TO SELECT MONO MODE

You can change the selection to "MONO" if you want to listen to HIFI tapes in normal audio playback.

- 1) Press the SETUP button on the remote control. Press the Arrow ▲ or ▼ button to point to "USER'S SET UP". Then, press the Arrow ► button.
- 2) Press the Arrow ▲ or ▼ button to point to "VCR AUDIO". Then, press Arrow ► button.
- 3) Press the Arrow ► or ◀ button until [MONO] appears.
- 4) Press the SETUP button on the remote control to return to TV mode.

TO SELECT STEREO, SAP, OR MONO

1 Select "USER'S SET UP"

Press the "SETUP" button on the remote control.

Press the Arrow ▲ or ▼ button to point to "USER'S SET UP". Then, press the Arrow ► button.

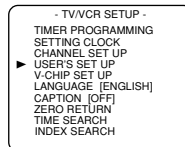

2 Select "TV AUDIO"

Press the Arrow ▲ or ▼ button to point to "TV AUDIO". Then, press the Arrow ► button.

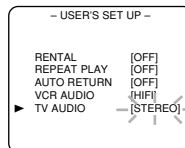

3 Select [STEREO], [SAP], or [MONO]

Press the Arrow ► or ◀ button until [STEREO], [SAP], or [MONO] appears.

4 To return to TV mode

Press the SETUP button on the remote control to return to TV mode.

NOTES:

- You must select the recording mode, either TV AUDIO [STEREO] or [SAP] when you record a broadcast. Refer to "MTS RECORDING/MONITOR MODE".
- If you select second audio when second audio is not available, the TV/DVD/VHS will record normal audio.

VIDEO CASSETTE

This TV/DVD/VHS will operate with any cassette that has the **VHS** mark. For best results, we recommend the use of high-quality tapes. Do not use poor quality or damaged tapes.

PRECAUTIONS

- Avoid moisture. Moisture condensation may occur on the tape if it is moved from a cold place to a warm place or visa versa. Before using a tape with these conditions, to avoid damage of the tape and your TV/DVD/VHS, wait until the tape has warmed to room temperature and the moisture has evaporated.
- Avoid extreme heat, high humidity and magnetic fields.
- Do not tamper with the cassette mechanism.
- Do not touch the tape with your fingers.

TWO DIFFERENT TAPE SPEEDS

Before recording, select the tape speed from : **SP mode** (Standard Play) or **SLP mode** (Super Long Play).

The table below shows the maximum recording/playback time using T60, T120 or T160 tapes in each mode.

| Tape Speed | Recording/Playback Time | | | |
|------------|-------------------------|---------|---------|-------------|
| | Type of tape | T60 | T120 | T160 |
| SP mode | | 1 hour | 2 hours | 2-2/3 hours |
| SLP mode | | 3 hours | 6 hours | 8 hours |

Note: You can play back a tape recorded in LP mode (Long Play).

INSERTING A CASSETTE

Insert the cassette in the direction as shown. Push in gently, but continuously, on the center-back of the cassette until it is drawn into the TV/DVD/VHS. The TV/DVD/VHS will automatically turn on.

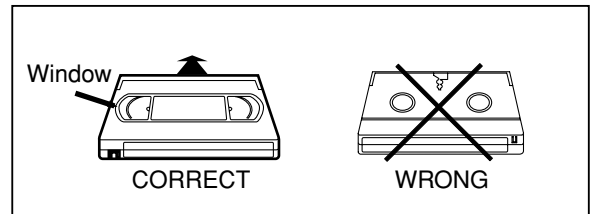

REMOVING A CASSETTE

- 1) In the Stop mode, press the EJECT button on the remote control or press the STOP/EJECT button on the TV/DVD/VHS. The cassette will eject.
- 2) Pull the cassette out of the cassette compartment.
- 3) Store the cassette in its case as shown.

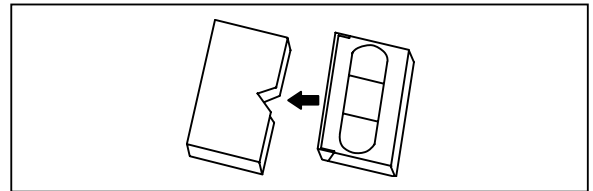

ERASE PREVENTION

You can prevent accidental erasing of recording by breaking off the tab on the back edge of the cassette.

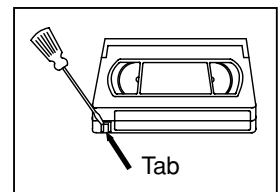

If you decide to record on the tape again, cover the hole with plastic tape.

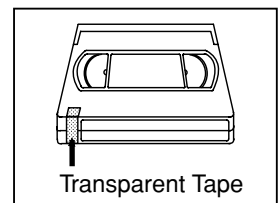

PLAYBACK

NORMAL PLAYBACK

Make sure ...

- TV/DVD/VHS power must be turned on.

1 Insert a prerecorded tape

If the erase-protection tab has been removed, the TV/DVD/VHS will start playback automatically.

2 To begin playback

Press the PLAY button.



3 To stop playback

Press the STOP button when playback is completed.



NOTES:

- If you press the TV/VCR side PLAY button in the DVD mode, you can start the VCR playback.
- If you press the SELECT button in the VCR playback, it will stop and the mode will change to the DVD mode. In addition, the same function operates with the DVD side PLAY button or OPEN/CLOSE button.

TRACKING ADJUSTMENT

- Tracking adjustment will be set automatically (Digital Tracking function) when you start playback.
- However when playing pre-recorded tapes or tapes recorded on units other than your own, noise lines (black and white streaks) may appear on the playback picture. If this occurs, you can adjust the tracking control manually by pressing the CHANNEL ▲ or ▼ button until the streaks disappear. To return to the DTR function, stop the tape once and start playback again.
- You can reduce the noise lines by pressing the CHANNEL ▲ or ▼ button in slow mode, too. Tracking adjustment in Slow mode will not be set automatically.

NOTE:

- In Still mode, press the SLOW button and press the CHANNEL ▲ or ▼ button until streaks disappear. To return to Still mode, press the PAUSE button again.

SLOW MOTION

During pause, press the FWD button to reduce the playback speed. The TV/DVD/VHS mutes the sound during slow motion. Press the PLAY button to return to normal playback.

NOTE: If it is left in the Slow mode for more than five minutes, the TV/DVD/VHS will automatically go into the Stop mode.

PICTURE SEARCH

This feature is very useful in finding or skipping over a particular scene on a tape. In this mode, the sound will be muted.

- 1) You may view a video tape at a high speed in either a forward or reverse direction by pressing the F.FWD or REW button. (in the SP / LP / SLP modes)

NOTE:

- If you press the F.FWD or REW button in the DVD mode, the VCR forward or reverse will start. Please press the STOP button to stop it.
- 2) Press it again and the TV/DVD/VHS will now search in super high speed. (in the LP / SLP modes only)
NOTE: Tapes recorded in the SP or LP mode will display a noise bar on the TV screen and the picture may revert to Black and White. This is normal.
 - 3) Press the PLAY button to return to normal speed.

STILL PICTURE

You can view a still picture on the TV screen during playback (the Still mode). Press the PAUSE button during playback. Only tapes recorded in the SLP mode will show the least amount of lines. Press the PLAY button to return to playback.

NOTES:

- You can advance the picture one frame at a time by pressing the PAUSE button during the Still mode.
- If it is left in the Pause mode for more than five minutes, the TV/DVD/VHS will automatically switch to the Stop mode.

VERTICAL HOLD CONTROL

In the Pause/Still mode only, when the picture begins to vibrate vertically, stabilize the picture by pressing the CHANNEL ▲ or ▼ button.

NOTE:

If there are video noise lines on the screen, see Tracking Adjustment section.

SPECIAL PLAYBACK

Make sure ...

- TV/DVD/VHS power must be turned on.
- Insert a prerecorded tape.
- Before playback, follow steps below.

RENTAL PLAYBACK

This function enables you to improve the picture quality when playing back worn cassettes such as rented tapes.

1 Select "USER'S SET UP"

Press the SETUP button on the remote control.

Press the Arrow ▲ or ▼ button to point to "USER'S SET UP".

Then, press the Arrow ► button.

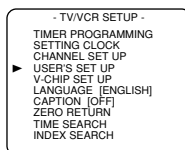

2 Set "RENTAL" to [ON]

Press the Arrow ▲ or ▼ button to point to "RENTAL".

Press the Arrow ► or ◀ button until [ON] appears.

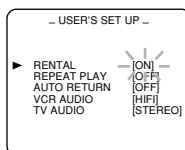

3 Exit the Rental setting

Press the SETUP button on the remote control to return to the TV mode.

4 Start playback

Press the PLAY button to start playback. "RENTAL PLAY ►" appears.

- Once you select the Rental mode, it stays in effect even after you turn off the TV/DVD/VHS.

TO CANCEL THE RENTAL MODE

Repeat steps [1] and [2], select [OFF] using the Arrow ► or ◀ button on the remote control. Press the SETUP button on the remote control to return to TV mode.

If there is a power failure of any kind, the unit will retain its memory for this feature.

AUTO REPEAT PLAYBACK

The TV/DVD/VHS has the auto repeat function that allows you to repeat a tape indefinitely without touching the PLAY button.

ALL REPEAT: Repeat playback from the beginning to the end of the tape.

BLANK REPEAT: Repeat playback from the beginning to a blank part, which is blank for more than 10 seconds.

1 Select "USER'S SET UP"

Press the SETUP button on the remote control.

Press the Arrow ▲ or ▼ button to point to "USER'S SET UP".

Then, press the Arrow ► button.

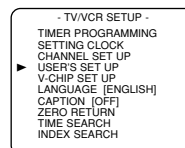

2 Select "ALL" or "BLANK"

Press the Arrow ▲ or ▼ button to point to "REPEAT PLAY".

Press the Arrow ► or ◀ button repeatedly until your desired selection [ALL] or [BLANK] appears.

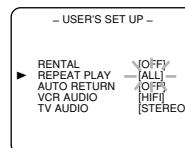

3 Exit the Repeat Play setting

Press the SETUP button on the remote control to return to the TV mode.

4 Start playback

Press the PLAY button to start the Repeat Play. "REPEAT PLAY ►" appears.

- Once you select the Repeat Play mode, it stays in effect even after you turn off the TV/DVD/VHS.
- If the Rental mode is set [ON], the "RENTAL PLAY ►" display has priority.

TO CANCEL THE REPEAT PLAY MODE

Repeat steps [1] and [2], select [OFF] using the Arrow ► or ◀ button on the remote control. Press the SETUP button on the remote control to return to TV mode.

If there is a power failure of any kind, the unit will retain its memory for this feature.

SEARCH

Make sure ...

- TV/DVD/VHS power must be turned on.
- Insert a tape.

ZERO RETURN

This function allows you to search easily a beginning point that you want to review by rewinding or fast forwarding.

NOTE:

Zero Return **WILL NOT** work on a blank tape or a blank portion of a tape.

1 Stop a tape at your desired point

Rewind or fast forward the tape to the beginning point at which you want to review.

2 Reset the counter to 0:00:00

Press the C.RESET button repeatedly.

3 Begin recording or playback

Press the RECORD or PLAY button.

Press the STOP button when recording or playback is completed.

4 To activate "ZERO RETURN" mode

Press the SETUP button on the remote control.

Press the Arrow ▲ or ▼ button to point to "ZERO RETURN".

Then, press the Arrow ► button.

The counter will appear on the TV screen.

The tape will automatically stop when the counter returns to 0:00:00.

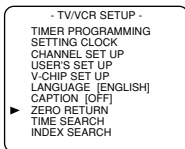

- This function will not operate in recording mode.
- This function is not operative when a cassette tape is not inserted in the TV/DVD/VHS.

In the example below: To watch a program after 2 hour 50 minutes from the present position, in either direction.

1 Insert a tape.

2 Select "TIME SEARCH" mode

Press the SETUP button on the remote control.

Press the Arrow ▲ or ▼ button to point to "TIME SEARCH".

Then, press the Arrow ► button.

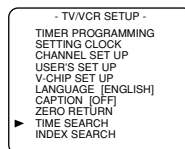

3 Enter your desired time

Press the Arrow ▲ or ▼ button until your desired time appears.

(Example: "2:50" stands for 2 hours 50 minutes)

If you wish to cancel the Time Search at this point, press the SETUP button on the remote control.

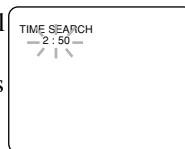

4 Begin Time Search

By pressing the Arrow ◀ or ▶ button, the TV/DVD/VHS will rewind or fast forward to the specified point.

The time counts down as the searching progresses. When 0:00 is reached, the tape will start playback automatically.

TIME SEARCH

The Time Search function makes it possible to quickly advance the tape to your desired position simply by entering the exact amount of playback time you want to skip.

NOTES:

- Time Search can be set up to a maximum of 9 hours 50 minutes (9:50) by 10 minutes at a time.

TO CANCEL THE TIME SEARCH at this point

Press the STOP/EJECT button on the TV/DVD/VHS or the remote control. This will delete the selected time.

INDEX SEARCH

This feature provides a method of indexing the starting point so that it can be easily returned to in either fast forward or rewind mode.

- The index mark will be made automatically when the REC button is pressed. It will also be marked at the starting point of Timer recording and OTR.
- The index mark will not be recorded if the PAUSE button is pressed and released during recording.
- The time gap between making the index marks on the tape should be greater than 1 minute for SP recording, 2 minutes for LP recording and 3 minutes for SLP recording.
- In some cases, the index mark at the beginning of video tape cannot be detected.

Example: You are watching program number 4 and want to fast forward to program number 7. You must skip three programs.

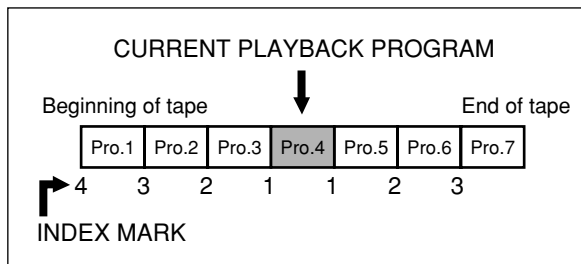

1 Select "INDEX SEARCH"

Press the SETUP button on the remote control.

Press the Arrow ▲ or ▼ button to point to "INDEX SEARCH". Then, press the Arrow ► button

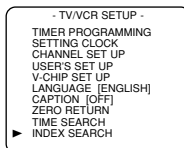

2 Enter your desired number

Press the Arrow ▲ or ▼ button until the number of programs that you want to skip appears.

(Example: "03" for 3 programs)

- The Index Search mode will be canceled if the procedures are not activated in 30 seconds.

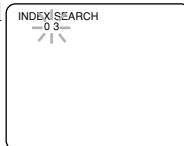

3 Begin Index Search

Press the Arrow ◀ or ▶ button. The TV/DVD/VHS begins rewinding or fast forwarding to the beginning of desired program.

NOTE: Every time an index signal is skipped, the number in the program indicator decreases by one.

4 After Index Search

When the preset program is reached, the TV/DVD/VHS will start playback automatically.

- A video cassette must be inserted in the TV/DVD/VHS for this function to work.
- The number of Index Searches can be set up to 20.
- This function will not operate in the recording mode.
- When you want to cancel the Index Search while in progress, press the STOP button.

SPECIAL FEATURES

REAL TIME TAPE COUNTER

This shows the elapsed recording or playback time in hours, minutes, and seconds. (The displayed time will not change on a blank tape or blank portions on the tape.) The "-" indication will appear when the tape has rewound further than "0:00:00" on the tape counter.

AUTO REWIND-EJECT

- When the end of a tape is reached during recording, playback, or fast-forward, the tape will automatically rewind to the beginning. After rewinding finishes, the TV/DVD/VHS will eject the tape and turn itself off.
- This function is operative when Repeat Play is set to the [OFF] position.
- The tape will not auto-rewind during timer recording or One Touch Recording.

RECORDING

Make sure ...

- TV/DVD/VHS power must be turned on.
- Insert a cassette tape with its erase prevention tab in place. (If necessary, rewind or fast forward the tape to the point at which you want to begin recording.)

NOTES:

- This unit will ONLY record and view the same channel.
- This unit cannot record the contents from the built-in DVD.

NORMAL RECORDING

You can ONLY watch the same TV program that is being recorded.

1 Select the channel to be recorded

Press the number buttons on the remote control or the CHANNEL ▲ or ▼ button.

Remember: If the TV/DVD/VHS is connected to a cable box or satellite box, the TV/DVD/VHS must be on CH3 or CH4, then the channel to be recorded must be selected on the cable box or satellite box.

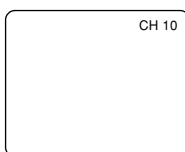

2 Select the tape speed

Press the SPEED button to select the desired tape speed (SP/ SLP).



3 Begin recording

Press the RECORD button.

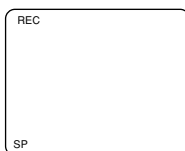

4 Stop recording

Press the STOP button when recording is completed.

SKIPPING UNWANTED SCENES DURING RECORDING

Press the PAUSE button to temporarily stop recording.

Press the PAUSE or RECORD button to resume recording.

NOTES:

- After five minutes, the TV/DVD/VHS will automatically switch to the Recording mode to prevent tape damage.
- If "CLOSED CAPTION (ON)" is selected, the On-Screen Display will appear for 5 seconds, then disappear.

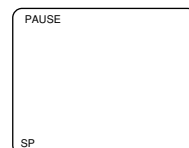

OTR (One Touch Recording)

This function enables you to set a recording length simply by pressing the REC/OTR button on the TV/DVD/VHS.

Make sure ...

- TV/DVD/VHS power must be turned on.
- Insert a cassette tape with its erase prevention tab in place. (If necessary, rewind or fast forward the tape to the point at which you want to begin recording.)

NOTES:

- This function CANNOT be done from the remote control.
- Recording starts immediately when the REC/OTR button is pressed.
- When the REC/OTR button is pressed 18 times, the TV/DVD/VHS returns to the Normal Recording mode.
- To stop the OTR operation, press the STOP button on the TV/DVD/VHS or on the remote control.
- To show the remaining time, press the DISPLAY button on the remote control so that "OTR" appears on the TV screen. (It will show up momentarily then disappear.)
- Recording stops when 0:00 is reached.
- Please note that in the SLP mode maximum recording time, assuming the tape is started at the beginning, is 8 hours using T-160 (or 6 hours using T-120).
- If the tape runs out before the end time, the TV/DVD/VHS will switch to the Stop mode immediately, ejects the tape and turns itself off.

1 Select the channel to be recorded

Press the number buttons on the remote control or the CHANNEL ▲ or ▼ button.

Remember: If the TV/DVD/VHS is connected to a cable box or satellite box, the TV/DVD/VHS must be on CH3 or CH4, then the channel to be recorded is selected on the cable box or satellite box.

2 Select the tape speed

Press the SPEED button to select the desired tape speed (SP/ SLP).

3 Begin OTR

Press the REC/OTR button on the TV/DVD/VHS as many times as needed. The recording length will be determined by the number of times you press the REC/OTR button. Each additional push will increase the recording time by 30 minutes. It is set up to 8 hours.

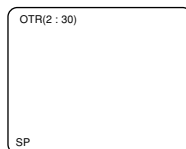

| Push(es) | Display | Recording length |
|-----------|---------|--------------------|
| 1 push | | (normal recording) |
| 2 pushes | 0:30 | 30 minutes |
| 3 pushes | 1:00 | 60 minutes |
| ↓ | ↓ | ↓ |
| 17 pushes | 8:00 | 480 minutes |

COPYING A VIDEO CASSETTE (Requires a VCR or camcorder)

You can make copies of video tapes made by friends or relatives for your enjoyment.

WARNING: Unauthorized recordings of copyrighted video tapes may be an infringement of copyright laws.

Connect your TV/DVD/VHS and a Source (Playing) VCR using the following diagram.

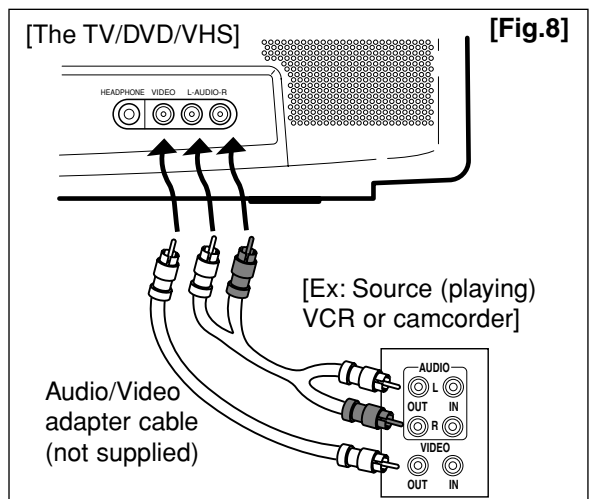

- 1) Insert a pre-recorded video cassette into the Source (Playing) VCR or camcorder.
- 2) Insert a blank video cassette, or one you want to record over, into the TV/DVD/VHS's cassette compartment.
- 3) Press the SPEED button on remote control for the TV/DVD/VHS to select the desired recording speed (SP/SLP).
- 4) Press the CHANNEL ▲ or ▼ button on the TV/DVD/VHS until "AUX" appears on the screen.
- 5) Press the RECORD button on the TV/DVD/VHS.
- 6) Begin playback of the tape in the source (Playing) VCR or camcorder.

NOTE: For best results during copying, use the TV/DVD/VHS's front panel controls whenever possible. The remote control might affect the source (Playing) VCR's playback operation.

TIMER

AUTOMATIC TIMER RECORDING

You may set the TV/DVD/VHS to start and end a recording while you are away. You can set 8 programs to record on specific days, daily or weekly within a 1 year period.

In the example below, the timer is being set to record:

DATE: July 5th, 2002
 SETTING TIME: from 7:30PM to 8:50PM
 CHANNEL: CH61
 TAPE SPEED: SP

Make sure ...

- If a cable box or satellite box is connected with the TV/DVD/VHS you will be limited to record only one channel. And the channel selector on the TV/DVD/VHS must be selected to the output channel of the boxes CH 3 or CH 4 and then the actual channel to be recorded must be selected on the boxes.
- Clock must be set to the correct time and date before setting the timer.
- TV/DVD/VHS power must be turned on to program it.
- Insert a cassette tape with its erase prevention tab in place. (If necessary, rewind or fast forward the tape to the point at which you want to begin recording.)
- The channel you want to record is properly set in advance. (See page 16.)

Avoid overlap of programs ...

There is a chance that a program will not be recorded, when programs overlap;

- The program with an earlier start has priority.
- Once the earliest program finishes, the overlapping programs will begin recording in sequence.
- The illustration below demonstrates the sequence of recordings.

Program 1 10:00AM - 11:00AM
 Program 2 9:00AM - 10:00AM
 Program 3 9:30AM - 12:00PM

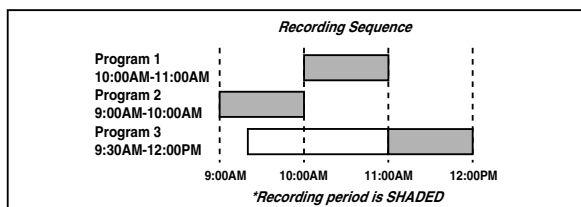

1 Select "TIMER PROGRAMMING"

Press the SETUP button on the remote control. Confirm "TIMER PROGRAMMING" is pointed by

pressing the Arrow ▲ button. And press the Arrow ► button.

- If you have not yet set the clock, "MANUAL CLOCK SET" appears. If so, follow steps [3] to [8] on page 18. Then set the timer recording.

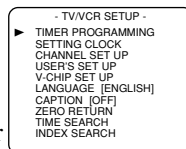

2 Select your desired program position (1-8)

Press the Arrow ▲ or ▼ button to select the desired program position. Then, press the Arrow ► button.

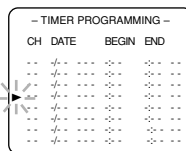

3 Set the channel number

Press the Arrow ▲ or ▼ button until the desired channel number appears.

(Example: CH61)

Then, press the Arrow ► button.

Remember: If the TV/DVD/VHS is connected to a cable box or satellite box, the TV/DVD/VHS must be on CH3 or CH4, then the channel to be recorded is selected on the cable box or satellite box.

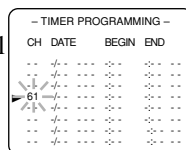

4 Select once, every day or weekly recording

For once recording :

Press the Arrow ▲ (up) button until the desired date appears. (Example: "7/05" for July 5th). Then, press the Arrow ► button.

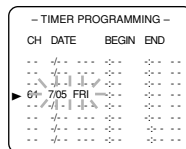

For every day recording : To record a TV program at the same time on the same channel every day. (Example: Monday through Sunday)

Press the Arrow ▼ (down) button until "EVRY DAY" appears. Then, press the Arrow ► button.

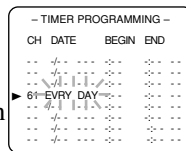

For weekly recording : To record a TV program at the same time on the same channel every week. (Example: every Monday)

Press the Arrow ▼ (down) button until "EVRY" and your desired day of the week appear together. Then, press the Arrow ► button.

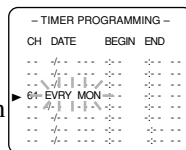

5 Set beginning hour

Press the Arrow ▲ or ▼ button until the desired hour appears.
(Example: “7, PM” for 7:30PM)
Then, press the Arrow ► button.

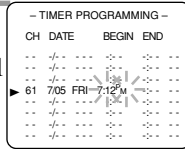

6 Set beginning minute

Press the Arrow ▲ or ▼ button until the desired minute appears.
(Example: “30” for 7:30PM)
Then, press the Arrow ► button.

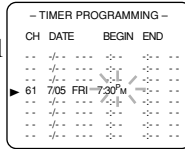

7 Set end hour

Press the Arrow ▲ or ▼ button until the desired hour appears.
(Example: “8, PM” for 8:50PM)
Then, press the Arrow ► button.

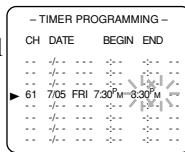

8 Set end minute

Press the Arrow ▲ or ▼ button until the desired minute appears.
(Example: “50” for 8:50PM)
Then, press the Arrow ► button.

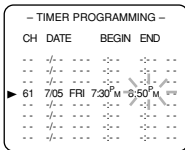

9 Set the tape speed

Press the Arrow ▲ or ▼ button until the desired tape speed appears. (Example: SP)

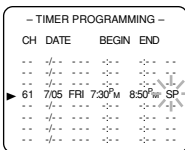

10 Finish setting the program

Press the Arrow ► or ◀ button. The program is now completed.

- To set another program, repeat steps [2] to [10].
- Press the SETUP button on the remote control to return to original mode.

11 Set the timer

Press the POWER button to set automatic timer recording. The TIMER REC indicator lights up.

- You must turn off the TV/DVD/VHS to activate automatic timer recording.

If power is not turned off and you continue watching TV, “TIMER REC STANDBY” starts flashing on the TV screen 2 minutes before the programmed start time.

TIMER PROGRAM EXTENSION

To shift the time schedule of an automatic timer recording.

- 1) Press the POWER button.
- 2) Repeat step [1] on page 32.
- 3) Press the RECORD button and select the desired program using the Arrow ▲ or ▼ button.
- 4) Press the RECORD button again.

Each additional push will shift forward the begin/end time for recording by 10 minutes. When the recording is already in progress, each additional push will shift forward the end time only. If you want to cancel while setting, press the PAUSE button on the remote control. The recording time returns to the original time.

NOTE: When you shift forward the time schedule during recording, the recording speed will automatically be set to the SLP mode.

- 5) Press the Arrow ► or ◀ button to exit the setting menu. Then press the SETUP button on the remote control to return to original mode.

TO CORRECT A PROGRAM

- **While setting a program;** press the Arrow ◀ button to go back one step and enter the correct numbers using the Arrow ▲ or ▼ button.
- **After setting a program;**
 - 1) Press the POWER button.
 - 2) Repeat steps [1] - [2] on page 32.
 - 3) Press the Arrow ► button (or press the Arrow ◀ button to go back one step) until the part you want to correct begins flashing, then make the changes pressing the Arrow ▲ or ▼ button.
 - 4) Press the POWER button to set automatic timer recording.

TO CANCEL AN AUTOMATIC TIMER RECORDING

- **After setting a program;**
 - 1) Press the POWER button.
 - 2) Repeat steps [1] ~ [2] on page 32 and select a program you want to cancel.
 - 3) Press the C.RESET button.
 - 4) Press the SETUP button on the remote control to return to TV mode.
- **While recording is in progress;**
 - 1) Press POWER button.
 - 2) Press the STOP/EJECT button on the TV/DVD/VHS.

TO CHECK THE BEGIN/END TIME

- 1) Press the POWER button so that the REC indicator goes off.
- 2) Press the SETUP button on the remote control.
- 3) Confirm "TIMER PROGRAMMING" is pointed.
- 4) Press the Arrow ► button. The details of programs appear on the TV screen.
- 5) Press the SETUP button on the remote control to return to TV mode.

HINTS FOR AUTOMATIC TIMER RECORDING

- Make sure the channel you want to record is properly set in advance.
- It is not necessary to press the RECORD button for timer recording.
- Recording begins automatically at the Start time.
- If you are recording using a Timer mode, you may not operate the unit manually.
- The erase-prevention tab on the cassette must be in place (or you must put tape over the hole).
- If the erase-prevention tab is removed, the cassette will be ejected when the POWER button is pressed to off.
- If the tape runs out before the end time, the TV/DVD/VHS will switch to the Stop mode immediately, and the tape will be ejected.

AUTO RETURN

With this feature, after timer recording is finished, the beginning of the recorded program(s) can be searched for automatically.

1 Select "USER'S SET UP"

Press the SETUP button on the remote control.

Press the Arrow ▲ or ▼ button to point to "USER'S SET UP". Then, press the Arrow ► button.

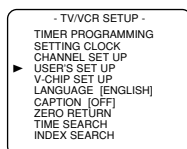

2 Set "AUTO RETURN" to [ON]

Press the Arrow ▲ or ▼ button to point to "AUTO RETURN". Press the Arrow ► or ◀ button until [ON] appears.

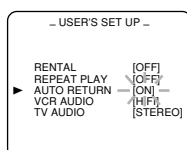

3 Auto Return will begin

When all the timer recordings are completed, the TV/DVD/VHS will rewind to the beginning of the recorded program(s).

NOTE:

- If you press the POWER button while tape is rewinding, the Auto Return will stop.

4 Watch the recorded program

Press the PLAY button.

TO CANCEL THE AUTO RETURN MODE

Repeat steps [1] and [2], select [OFF] using the Arrow ► or ◀ button.

If there is a power failure of any kind, the unit will retain its memory for this feature.

SLEEP TIMER

The Sleep Timer function turns off the TV/DVD/VHS without using the POWER button after a desired period of time.

NOTE:

- This function does not operate during Recording mode.

1 Select "SLEEP TIMER"

Press the SLEEP button on the remote control until "SLEEP TIMER" appears.

2 Set sleep time

Press the SLEEP button until your desired sleep time appears.

Each additional push will increase the time by 30 minutes up to 120 minutes.

After 5 seconds, exit the Sleep Timer setting.

SLEEP 120 MINUTES

TO CANCEL THE SLEEP TIMER

Press the SLEEP button on the remote control until "SLEEP TIMER" appears. Press the SLEEP button until "SLEEP 0 MINUTES" appears.

ON SCREEN DISPLAY

To check the Counter, Clock and Channel number on the TV screen, press the DISPLAY button on the remote control. Each time you press the DISPLAY button on the remote control, the TV screen will change as follows:

When the Closed Caption mode is OFF:

- Counter mode: After 5 seconds, only the counter remains. To clear it, press the DISPLAY button.
- Clock mode: After 5 seconds, only the clock and the channel number remain. To clear them, press the DISPLAY button.

When the Closed Caption mode is ON:

- The On Screen Display disappears after 5 seconds.
- This is true even if the MUTE button is pressed, or the PAUSE button is pressed while recording.

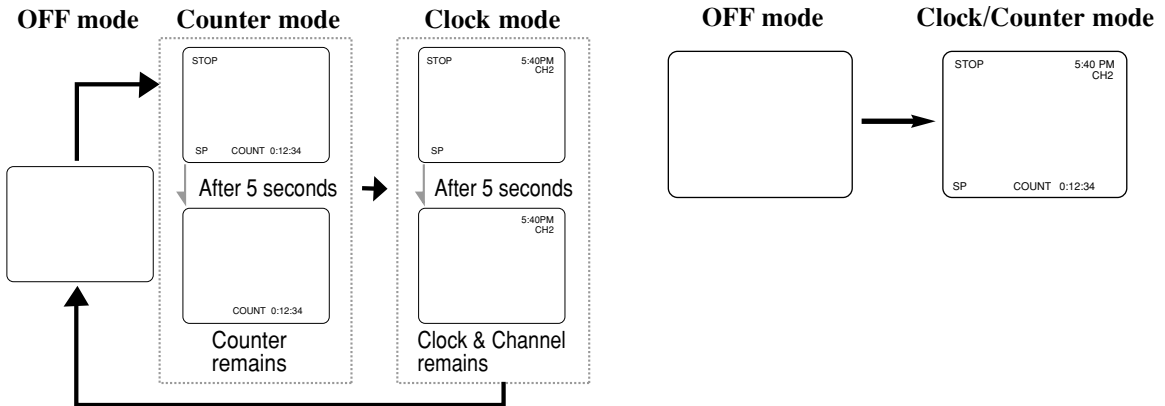

CABLE CHANNEL DESIGNATIONS



If you subscribe to cable TV, the channels are displayed as 1-125. Cable companies often designate channels with letters or letter-number combinations. Please check with your local cable company. The following is a chart of common cable channel designations.

| | | | | | | | | | | | | | | | |
|--------------|------|------|------|------|------|------|------|------|------|------|------|------|------|------|------|
| CATV channel | 5A | 2 | 3 | 4 | 5 | 6 | 7 | 8 | 9 | 10 | 11 | 12 | 13 | A | B |
| TV Display | 1 | 2 | 3 | 4 | 5 | 6 | 7 | 8 | 9 | 10 | 11 | 12 | 13 | 14 | 15 |
| CATV channel | C | D | E | F | G | H | I | J | K | L | M | N | O | P | Q |
| TV Display | 16 | 17 | 18 | 19 | 20 | 21 | 22 | 23 | 24 | 25 | 26 | 27 | 28 | 29 | 30 |
| CATV channel | R | S | T | U | V | W | W+1 | W+2 | W+3 | W+4 | W+5 | W+6 | W+7 | W+8 | W+9 |
| TV Display | 31 | 32 | 33 | 34 | 35 | 36 | 37 | 38 | 39 | 40 | 41 | 42 | 43 | 44 | 45 |
| CATV channel | W+10 | W+11 | W+12 | W+13 | W+14 | W+15 | W+16 | W+17 | W+18 | W+19 | W+20 | W+21 | W+22 | W+23 | W+24 |
| TV Display | 46 | 47 | 48 | 49 | 50 | 51 | 52 | 53 | 54 | 55 | 56 | 57 | 58 | 59 | 60 |
| CATV channel | W+25 | W+26 | W+27 | W+28 | W+29 | W+30 | W+31 | W+32 | W+33 | W+34 | W+35 | W+36 | W+37 | W+38 | W+39 |
| TV Display | 61 | 62 | 63 | 64 | 65 | 66 | 67 | 68 | 69 | 70 | 71 | 72 | 73 | 74 | 75 |
| CATV channel | W+40 | W+41 | W+42 | W+43 | W+44 | W+45 | W+46 | W+47 | W+48 | W+49 | W+50 | W+51 | W+52 | W+53 | W+54 |
| TV Display | 76 | 77 | 78 | 79 | 80 | 81 | 82 | 83 | 84 | 85 | 86 | 87 | 88 | 89 | 90 |
| CATV channel | W+55 | W+56 | W+57 | W+58 | A-5 | A-4 | A-3 | A-2 | A-1 | W+59 | W+60 | W+61 | W+62 | W+63 | W+64 |
| TV Display | 91 | 92 | 93 | 94 | 95 | 96 | 97 | 98 | 99 | 100 | 101 | 102 | 103 | 104 | 105 |
| CATV channel | W+65 | W+66 | W+67 | W+68 | W+69 | W+70 | W+71 | W+72 | W+73 | W+74 | W+75 | W+76 | W+77 | W+78 | W+79 |
| TV Display | 106 | 107 | 108 | 109 | 110 | 111 | 112 | 113 | 114 | 115 | 116 | 117 | 118 | 119 | 120 |
| CATV channel | W+80 | W+81 | W+82 | W+83 | W+84 | | | | | | | | | | |
| TV Display | 121 | 122 | 123 | 124 | 125 | | | | | | | | | | |

ABOUT THE DISCS

PLAYABLE DISCS

The following discs can be played back on this DVD player.

| Disc Type | Logo | Contents | Disc Size | Maximum Playback Time |
|-----------|---|--------------------|----------------|---|
| DVD Video |  | Sound and Pictures | 12 cm | Approx. 4 h (single-sided) Approx. 8 h (double-sided) |
| | | | 8 cm | Approx. 80 min (single-sided) Approx. 160 min (double-sided) |
| Audio CD |  | Sound | 12 cm | 74 min |
| | | | 8 cm (singles) | 20 min |

This player conforms to the NTSC color system. You cannot play discs recorded in other color systems such as PAL or SECAM.

- Some discs include region codes as shown below.



- The number inside the symbol refers to a region of the world, and a disc encoded in a specific region format can only be played back on DVD players with the same region code.

The following discs cannot be played back on this DVD player.

- DVD with region codes other than 1 or ALL.
- DVD-ROM
- DVD-RAM (Never play back, otherwise malfunction may result.)
- CD-ROM
- VSD
- CDV (Only plays back the audio part.)
- CD-G (Only plays back the sound.)
- CD-R (Never play back, otherwise malfunction may result.)
- CD-I (Never play back, otherwise malfunction may result.)

- Photo CD (Never play back, otherwise malfunction may result.)
- Video CD (Never play back, otherwise malfunction may result.)

Any other discs without compatibility indications

DISC TYPES

[DVD]

Data on a DVD is divided into sections called "titles", and then into subsections called "chapters", each of which is given a title or chapter number. Playback conditions are preset on some DVD video discs, and these playback conditions take priority over user operations on this player. If a function you selected does not run as desired, refer to the manual accompanying the disc.

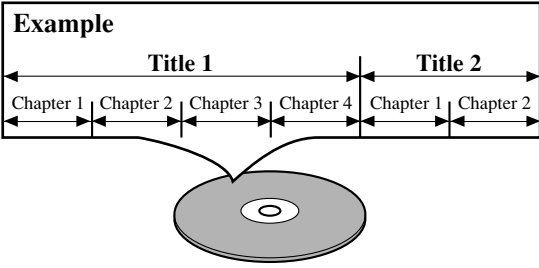

[AUDIO CD]

Data on an audio CD is divided into sections called "tracks", each of which is given a track number.

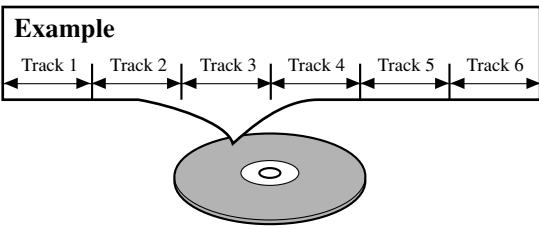

PLAYING A DISC

PLAYING A DVD VIDEO OR AN AUDIO CD

DVD

CD

Getting started

Turn on the power of the TV, amplifier and any other components which are connected to the DVD player. (Change the input system to suit the DVD player, and check that the sound volume is correct.)

1 Press the POWER button.

- The power will turn on.

2 Press the OPEN/CLOSE button.

- The disc loading tray will open.

3 Place a disc into the tray.

- Make sure the disc is sitting properly in the correct recess, with the label side up.

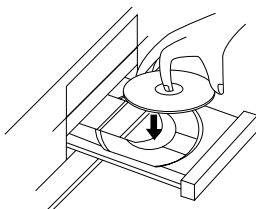

4 Press the PLAY button.

- The tray will close automatically, and playback will then start from the first chapter or track of the disc. You need to press the PLAY button only when the tray has been closed by pressing the OPEN/CLOSE button.
- When you play back the DVD which a title menu is recorded, the menu may appear on the screen. In this case, refer to “USING THE TITLE MENU”.

5 Press the STOP button to stop play.

Notes

- If you press the OPEN/CLOSE button in the TV/VCR mode or power-off, the DVD tray will open.
- If you press the DVD side PLAY button in the TV/VCR mode or power off, you can start the DVD playback.
- A “prohibited icon” may appear at the top-right on the TV screen during operation, warning that a prohibited operation has been encountered by the DVD player or the disc.



- If a disc is dirty or has scratches, the pictures may appear distorted and the playback operation may stop. In such cases, clean the disc and unplug the power cord and then plug it again before resuming playback.
- With DVDs that use some titles for playback program signals, playback may start from the second title, or it may skip these titles.

USING THE DVD MENUS

DVD

Some DVDs contain their own menus, such as a guidance menu which describes the contents of the disc or a selection menu for sound, language and other customized settings.

1 Press the DISC MENU button.

- The DVD menu will appear.

2 Select the desired title.

- Press the arrow buttons (▼/▲/▶/◀) to change the setting, and then press the ENTER button.

3 Playback will start from the selected title.

USING THE TITLE MENU

DVD

With a DVD containing a title menu, you can select desired titles from the menu.

1 Press the TITLE button.

- The title menu will appear.

2 Select the desired title.

- Press the arrow buttons (▼/▲/▶/◀) to change the setting, and then press the ENTER button.

CALLING UP A MENU SCREEN DURING PLAYBACK

For DVDs

- Press the DISC MENU button to call up the DVD menu.
- Press the TITLE button to call up the title menu.

Note

- Contents of menus and corresponding menu operations may vary between discs. Refer to the manual accompanying the disc for details.

RESUMING PLAYBACK FROM THE POINT WHERE PLAYBACK STOPPED

DVD

CD

1 Press the STOP button during playback.

- Playback will stop, and then appear the resuming message at the center.



2 Press the PLAY button. Playback will start from the point where the previous playback session was stopped.



- 2 Press the PLAY button to return to normal playback speed.

PAUSING PLAYBACK OR DISPLAYING A STILL PICTURE

DVD

CD

1 Press the PAUSE button during playback.

- Playback will pause, with sound muted.



2 Press the PLAY button to resume playback.



Notes

- Resuming playback is not available with some discs.
- It is possible to switch from the DVD play mode to the TV mode. Even if the power is turned off, the resume function enables to playback on from the previously interrupted point. But note that the Marker commands are not saved.
- The resume function can be reset by pressing the STOP button twice or by opening the disc loading tray.

STEPPING THROUGH FRAMES

DVD

1 Press the PAUSE button while playback is paused.

- The next picture frame is displayed with sound muted each time the button is pressed.

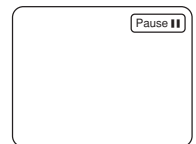

2 Press the PLAY button to resume playback.



FAST FORWARD/REVERSE

DVD

CD

1 Press and hold the >>> or <<<< button for more than 1 second during playback.

- For DVDs, pressing and more than 1 second holding the >>> or <<<< button cycles the playback speed in three steps.
- For audio CDs, the playback speed is $\times 16$ fixed.

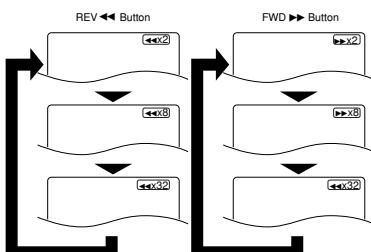

SLOW MOTION

DVD

1 Press and hold the ►► button for more than 1 second while playback is paused. (Sound remains muted.)

- Slow motion mode will be activated.
- Pressing and holding the ►► button for more than 1 second cycles the playback speed in three steps. Select an appropriate speed while referring to the speed indication on the screen.

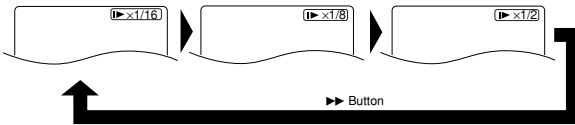

2 Press the PLAY button to return to normal playback speed.

Notes

- Slow playback is not available with audio CDs.
- The reverse of slow playback is not available.
- If you press the ►► button and release immediately during playback is paused or slow, it returns to normal playback.

PLAYING FROM A DESIRED TITLE OR CHAPTER

DVD

You can also press the SEARCH MODE button, use the numeric buttons to enter the chapter number.

- Perform the title search and the chapter search after setting them on the same screen at the same time. Changeover by ▲▼ buttons.

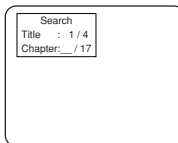

Note

- Playback from a desired title or chapter is not available with some DVDs.

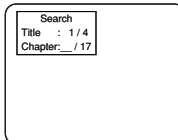

STARTING FROM A DESIRED TIME COUNT

DVD

CD

1 Press the SEARCH MODE button.

- Press the button twice.

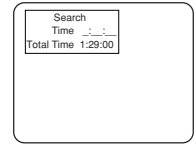

2 Press the numeric buttons to set the desired time count.

- **Example:** 1 hour, 23 minutes and 30 seconds
1 → 2 → 3 → 3 → 0

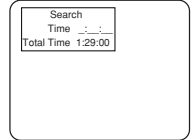

Notes

- In the case of DVD, Time Search in Title is effective. (But Time Search in Chapter is ineffective.)
- In the case of CD, Time Search in Track is effective. (But Time Search in the entire disc is ineffective.)
- Playback from a desired time count is not available with some discs.
- Specific time playback is not available with some discs or if the unit is in stop mode.

STARTING FROM A DESIRED TRACK

CD

1 Press the SEARCH MODE button.

Use the numeric buttons to enter the track number. When the track number is entered in the entry box, playback of the desired track will start automatically.

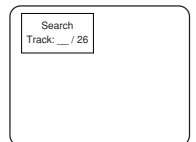

TRICKS WITH THE SKIP BUTTONS (◀◀, ▶▶)

If the SKIP button ▶▶ is pressed during playback or while playback is paused, the current track is skipped and the next track is played. When the SKIP button ◀◀ is pressed once, the top of the current track is located for replaying. When the SKIP button ◀◀ is pressed again while Within 2-second playback, the previous track is located.

REPEAT

DVD

CD

1 Press the REPEAT button.

For DVDs

- A single title or chapter is played back repeatedly.
- Pressing the REPEAT button cycles the display on the screen as follows.

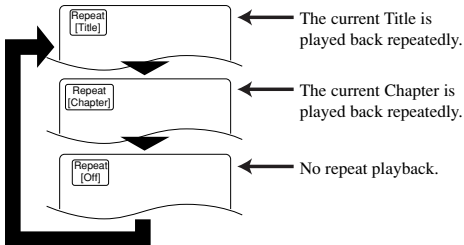

For audio CDs

- The whole disc or a single track is played back repeatedly.
- Pressing the REPEAT button cycles the display on the screen through **All**, **Repeat Track** and **Off**.

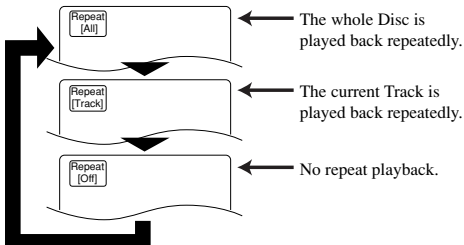

If the REPEAT button is pressed once during program/random playback, the program/random playback is performed repeatedly.

If the REPEAT button is pressed again, the current track is played back repeatedly.

Notes

- Repeat playback is not available with some discs.
- The REPEAT setting will be cleared when moving to other title, chapter or track.

A-B REPEAT

DVD

CD

You can define a section to be played back repeatedly.

1 Press the A-B REPEAT button during playback.

- The starting point (A) will then be selected.

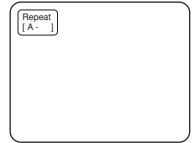

2 Press the A-B REPEAT button again at the end point (B) of the desired section.

- The selected section will be played back repeatedly.

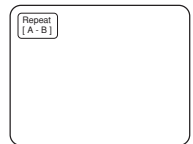

3 To exit A-B repeat playback, press the A-B REPEAT button and set it to OFF.

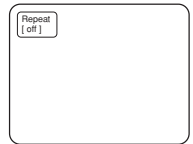

Notes

- With DVDs, the A-B repeat section can be set only within the current title.
- With audio CDs, the A-B repeat section can be set within the current track.
- A-B repeat is not available with some scenes in DVD.
- To cancel the A point which was set, press RETURN button.

PROGRAM (Audio CD)

CD

1 Press the MODE button in stop mode.

- The program screen will appear.

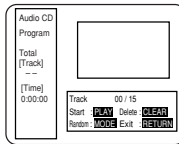

2 Press the numeric buttons to enter the desired track numbers.

- The total playback time for the selected tracks will appear on the TOTAL line.

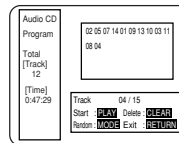

3 Press the PLAY button.

- Playback will start in the programmed order.
- While the program is being played back, the STOP button works as follows.
- Press the STOP button once and then the PLAY button again, playback will restart from the point where the STOP button was pressed. (Program continued)
- Press the STOP button twice and then the PLAY button again, playback will restart from the first tune in the program in the usual way. (Program continued)
- Press the STOP button three times and then the PLAY button again, playback will restart from the track in the usual way. (Program cleared)

Notes

- Adding programs is not possible during program playback. You must stop the current playback before such operations can be carried out.
- Press the CLEAR button to cancel a program. The most recently entered program will then be deleted.
- Numbers which exceed the number of tracks on the disc in the tray are not accepted.
- Playback from a desired track and random playback are not available during program playback.
- Program settings are cleared when the power is turned off or the disc loading tray is opened.
- If the track no. is once set in the program, the setting cannot be changed.

RANDOM (Audio CD)

CD

1 Press the MODE button in stop mode.

- The program setting menu screen will appear.

2 Press the MODE button again.

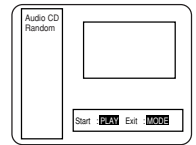

3 Press the PLAY button. Random playback will then start.

Note

- Program playback is not available during random playback.

ZOOM PLAYBACK (enlargement onscreen)

DVD

Images can be enlarged four times on the screen to your taste.

Press the ZOOM button during playback.

- An image will be enlarged at the center of the screen.
- Press the ZOOM button again, and the image will be back to the previous size.

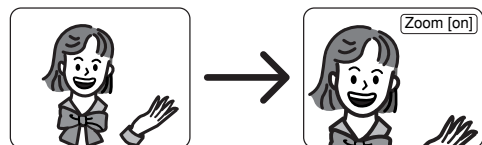

When the cursor (▲/▼/◀/▶) button is pressed during zoom play, the part to be zoomed moves.

- The zooming frame can be moved from the center 4 steps to the right. 4 steps to the left. 4 steps to the top. 4 steps to the bottom.

Note

- Zooming function does not work while operation display screen is shown.

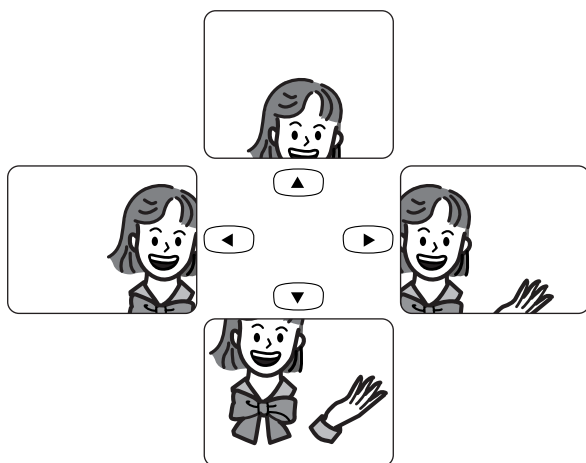

SETTINGS

CHANGING THE AUDIO LANGUAGE OR SOUND MODE

DVD

The DVD player has a function which allows you to select the desired audio language and sound mode.

For DVDs

Press the **AUDIO** button during playback, and then press the **AUDIO** button to select the desired audio language.

- The audio language can be changed if multiple languages are recorded on the DVD being played.

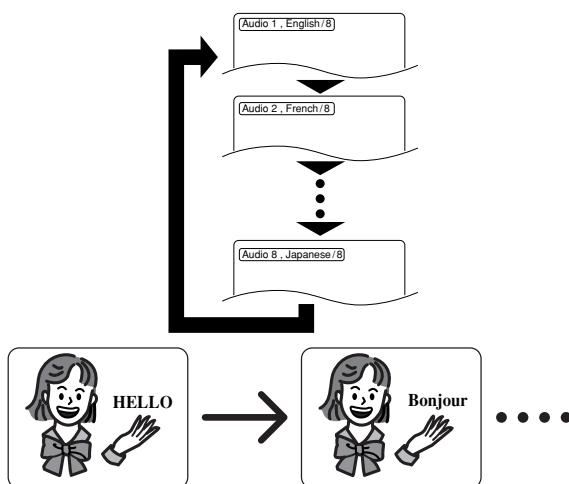

Notes

- Pressing the Audio button may not work on some DVDs with multiple audio languages (e.g. DVDs which allow audio language setting on the disc menu). Operation varies between discs, so refer to the manual accompanying the disc.
- If a desired language is not shown after pressing the Audio button several times, the disc does not have an audio source in that language.
- The audio language resets to the one which has been selected in the setup mode, every time the power is turned on or discs are replaced. If that language is not available on a disc, a language defined by the disc is selected.
- The screen display will disappear after about 5 seconds.

CHANGING THE SUBTITLE LANGUAGE

DVD

The DVD player has a function which allows you to select the desired language for subtitles.

Press the **SUBTITLE** button during playback, and then press the **SUBTITLE** button to select the desired subtitle language.

- The subtitle language can be changed if the subtitles are recorded in multiple languages on the DVD being played.
- The subtitle language cannot be changed if the subtitles are recorded in a single language on the DVD being played.

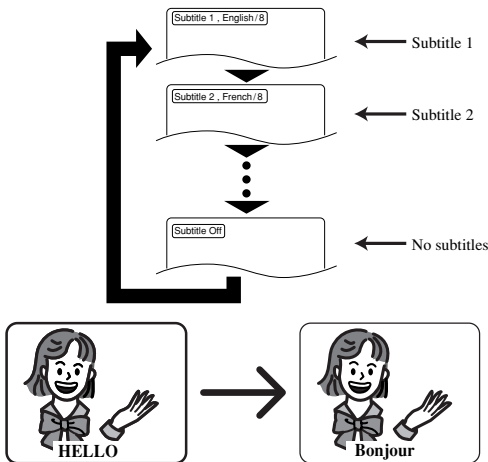

- Pressing the **SUBTITLE** button cycles the subtitle language from **SUBTITLE 1**, **SUBTITLE 2** and all the languages recorded through to off.

Notes

- Some discs allow subtitle language setting on the disc menu. (Operation varies between discs, so refer to the manual accompanying the disc.)
- If the desired language is not shown after pressing the **SUBTITLE** button several times, the disc does not have subtitles in that language.
- The subtitle language resets to the one which has been selected in the setup mode, every time the power is turned on or discs are replaced. If that language is not available on a disc, a language defined by the disc is selected.
- It may take time to display the subtitles in the selected language.
- The screen display will disappear after about 5 seconds.
- When “Subtitle Not Available” appears onscreen, it means no subtitle is recorded on the scene.

CHANGING THE CAMERA ANGLE (Multi-Angle Pictures)

DVD

The DVD player has a function which allows you to select the desired camera angle.

1 Press the **ANGLE** button during playback.

- If the disc contains sequences recorded from different camera angles, the angle icon () will appear at the top-right of the screen. You can change the camera angle when the icon appears on the screen.
- The camera angle cannot be changed if the disc does not contain sequences recorded from different camera angles.

2 Press the **ANGLE** button while the angle number is shown on the screen.

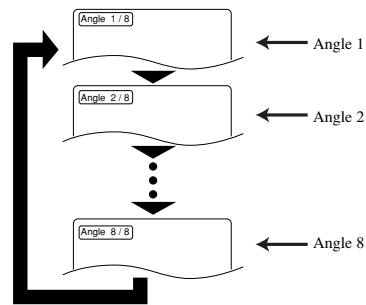

Note

- The screen display will disappear after about 5 seconds.

CHANGING THE ON-SCREEN DISPLAY

DVD

CD

You can check the information about the disc by pressing the DISPLAY button on the remote control.

For audio CDs and DVDs

1

Press the DISPLAY button, the display appears on the screen.

2

For the selecting the item of the Playback Setup Window, press the ▲/▼ button to select the item, then press the ENTER button.

For audio CDs

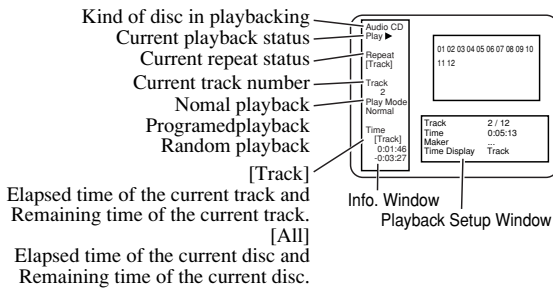

Playback Setup Window (CD)

| ITEM | DISPLAY CONTENTS |
|--------------|--|
| Track | Current track number / the number of total tracks |
| Time | Total time of the current track |
| Marker | Place the cursor and press the ENTER button to activate the Marker function. [Set the marker] Using ▲/▼ button, position the cursor on to the marker number shown as "Not Set". Press the ENTER button when the screen to be reviewed appears. Up to 5 points can be marked. [Call back the marker] Using ▲/▼ button, position the cursor on to the marker number to be called back and press the ENTER button. [Clear the marker] Using ▲/▼ button, position the cursor on to the marker number to be cleared and press the CLEAR button. To clear all markers, place the cursor on "All Clear Markers" and press the ENTER button. |
| Time Display | The time informations displays on the left side of the screen (Track/All) |

For DVDs

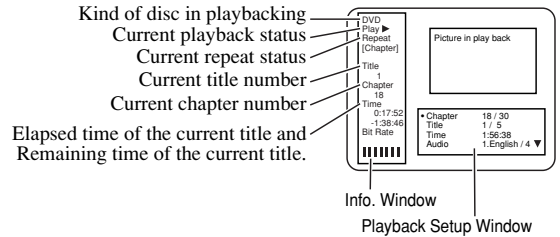

Playback Setup Window (DVD)

| ITEM | DISPLAY CONTENTS |
|-----------------|--|
| Chapter | Current chapter number / the number of total chapters |
| Title | Current title number / the number of total titles |
| Time | Total time of the current title |
| Audio | Audio No., audio language / the number of available audio languages in the disc |
| Subtitle | Subtitle No., subtitle language / the number of available subtitle languages in the disc Off : Subtitle is not displays. Not Available : Subtitle is not included. |
| Angle | Angle No. / total number of the angles 1/1 : Multi angle is not included in the disc. |
| Marker | Place the cursor and press the ENTER button to activate the Marker function. [Set the marker] Using ▲/▼ button, position the cursor on to the marker number shown as "Not Set". Press the ENTER button when the screen to be reviewed appears. Up to 5 points can be marked. [Call back the marker] Using ▲/▼ button, position the cursor on to the marker number to be called back and press the ENTER button. [Clear the marker] Using ▲/▼ button, position the cursor on to the marker number to be cleared and press the CLEAR button. To clear all markers, place the cursor on "All Clear Markers" and press the ENTER button. |
| SRS TruSurround | The current setting (On/Off) is displayed. |

To exit the display (DVD and CD):

Press the RETURN button.

In the playback Setup Window, press the RETURN button to change the present indication to the former one.

CHANGING THE SETUP ITEMS

Note

- When you change the setup items, press the STOP button if you are in playback mode.

LANGUAGE SETTINGS

1 Press the SETUP button.

- The setup screen appears.

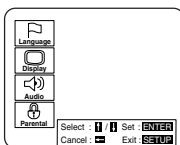

2 Press the ▲/▼ buttons to select Language, and then press the ENTER button.

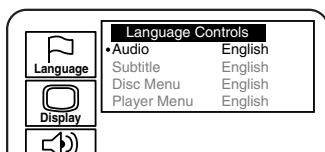

3 Press the ▲/▼ buttons to select an item, and then press the ENTER button.

(Voice is played back in selected language.)

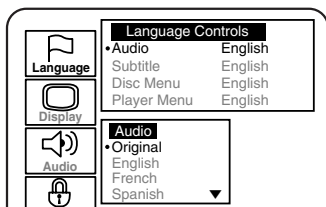

(Subtitles are shown in selected language.)

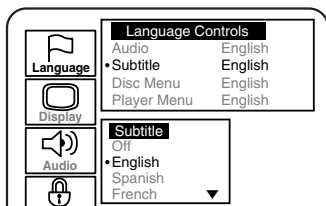

(The disc menu appears in selected language.)

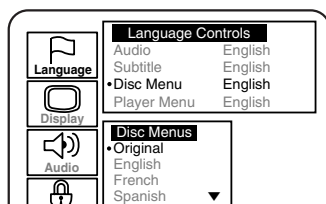

(The on-screen display appears in selected language.)

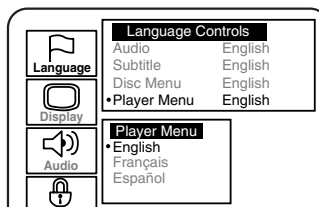

4 Press the ▲/▼ buttons to select a desired item, and then press the ENTER button.

- If Other is selected on the Audio, Subtitle or Disc Menu setting screen, the Language Code setting screen will appear. Press the numeric buttons to enter the desired language code while referring to the list on page 49.

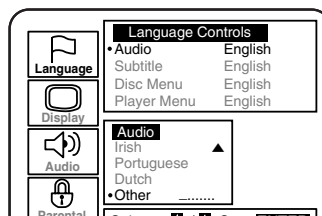

5 Press the SETUP button.

- The setup mode will be canceled and the ordinary screen will appear.

Note

- Language Setting for Audio and Subtitle is not available with some discs. Then use the Audio and Subtitle button. Details are on pages 42 and 43.

DISPLAY SETTINGS

1 Press the SETUP button.

- The setup screen will appear.

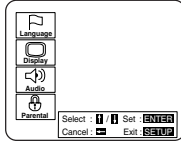

Background Color (Default : Gray)
Select gray or blue.

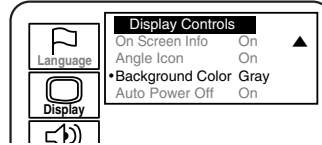

2 Press the ▲/▼ buttons to select Display and then press the ENTER button.

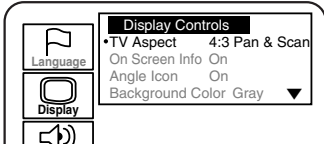

Auto Power Off (Default : On)
Set or not set to turn off after the screen saver is started and no keys are pressed for 30 minutes.

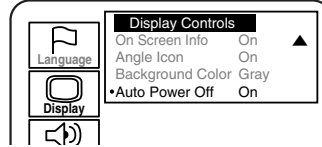

3 Press the ▲/▼ buttons to select an item, and then press the ENTER button.

4 Press the ▲/▼ buttons to select a desired item, and then press the ENTER button.

5 Press the SETUP button.

- The setup mode will be canceled and the ordinary screen will appear.

TV Aspect

(Default : 4:3 Pan & Scan)

4:3 Pan & Scan : Full height picture, trimmed both sides

4:3 Letter Box : Wide screen with black bars on top and bottom

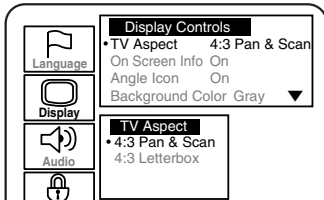

Notes

- Some discs do not contain pan and scan images.
- Some discs do not contain letter box images.

On Screen Info (Default : On)

Display or not display the disc status (Example “PLAY▶”).



Angle Icon (Default : On)

Display or not display the Angle icon on the screen.

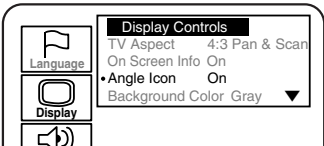

AUDIO SETTINGS

1 Press the SETUP button.

- The setup screen will appear.

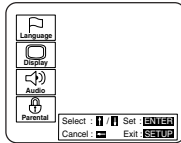

2 Press the ▲/▼ buttons to select Audio and then press the ENTER button.

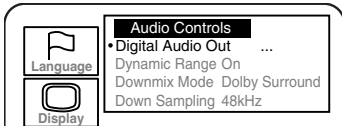

3 Press the ▲/▼ buttons to select an item, and then press the ENTER button. (Choose Digital Audio Out and press the ENTER button to set Dolby Digital, DTS, and MPEG. Go to step 4.)

Digital audio out setting (Next step)

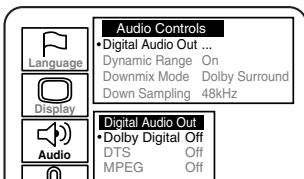

If you select Digital Audio Out, the screen changes to step 4. If you want to set other items of step 3, press the ▲/▼ buttons.

Dynamic Range (Default : Off)

On : Dynamic range is available

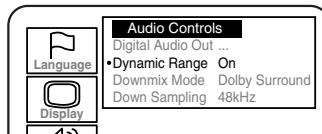

To select Dynamic Range On or Off, press the ENTER button repeatedly.

- This function is for controlling the range of sound volume. By compressing the range of sound volume, it is possible not only to suppress the output of loud sound at night and but also to raise the volume of low sound.
- However, this function is effective only for the sound recorded by Dolby Digital recording. When the sound recorded by Dolby Digital 5.1ch is outputted, the sound is compressed automatically even with this function being set at "Off".

Downmix Mode

(Default: Dolby Surround)

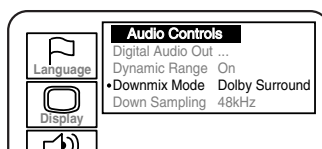

To select Downmix Mode Stereo or Dolby Surround, press the ENTER button repeatedly.

Dolby Surround: When the unit is connected to an audio component that conforms to

Dolby Surround Pro Logic

Stereo: When the unit is connected to a normal audio component

Down Sampling (Default : 48kHz)

Set the output for the DVD recorded in PCM 96kHz (96kHz or 48kHz)

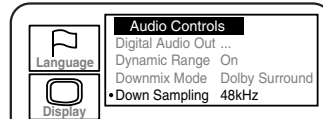

To select Down Sampling 48kHz or 96kHz, press the ENTER button repeatedly.

4 Press the ▲/▼ buttons to select a desired item, and then press the ENTER button.

- If PCM, Dolby Digital or DTS MPEG is selected on the Digital Audio Out setting screen, press the ▲/▼ buttons again to select a further item, and then press the ENTER button.

Dolby Digital (Default : Off)

On : Output by Dolby Digital.

Set to On when the unit is connected to Dolby Digital Decoder.

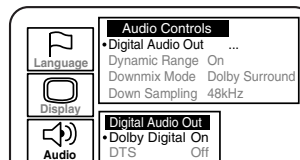

To select Dolby Digital On or Off, press the ENTER button repeatedly.

DTS (Default : Off)

On : Output DTS sound

Set to On when the unit is connected to DTS Decoder.

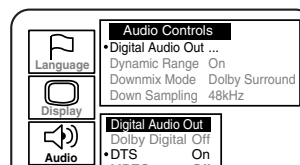

To select DTS On or Off, press the ENTER button repeatedly.

MPEG (Default : Off)

On : Output by MPEG

Off : Convert the MPEG to PCM

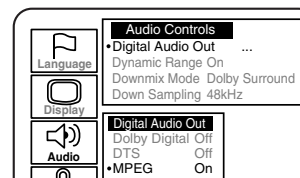

To select MPEG On or Off, press the ENTER button repeatedly.

Set to On when the unit is connected to MPEG2 Decoder.

5 Press the SETUP button.

- The setup mode will be canceled and the ordinary screen will appear.

PARENTAL LOCK

1 Press the SETUP button.

- The setup screen will appear.

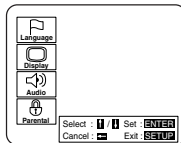

2 Press the ▲/▼ buttons to select Parental, and then press the ENTER button.

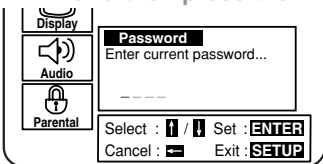

3 Press the numeric buttons to enter the 4-digit password, and then press the ENTER button.

- When doing this for the first time, enter any 4 digits. That number will be used as the password from the second time onward.
- By entering the password, you can then change the control level and password settings.

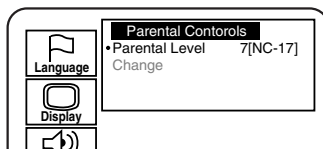

4 Press the ▲/▼ buttons to select an item, and then press the ENTER button.

When Parental Level is selected

- Press the ▲/▼ buttons to select an item from 8 to 1 and then press the ENTER button.
- When Change is selected, press the numeric buttons to enter the four digits password. Then press the ENTER button.

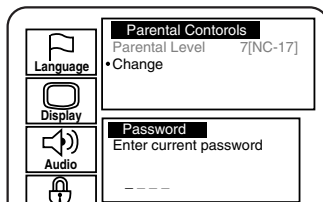
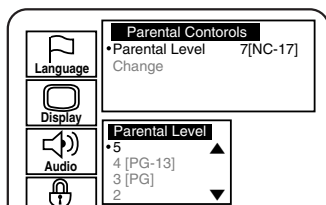

5 Press the RETURN button.

- The setup screen will appear.

CONTROL LEVELS

• Level 8

DVD software of any grade (adult/general/children) can be played back.

• Levels 7 to 2

Only DVD software intended for general use and children can be played back.

• Level 1

Only DVD software intended for children can be played back, with those intended for adult and general use prohibited.

Notes

- With some DVDs, it may be difficult to find if they are compatible with parental lock. Be sure to check if the parental lock function operates in the way that you have set.
- Record the password in case you forget it.

IF YOU FORGET THE PASSWORD

- 1) Open the tray.
- 2) Press the 1, 2, 3, 4, then DISPLAY button on the remote control. the default setup screen will appear. Then, press the ENTER button.
- 3) Disconnect the power once and reconnect, then proceed the step 1 to 4 of the PARENTAL LOCK again.

Note: If you proceed the above steps, ALL the settings of the DVD player will be cleared. To use the DVD player under the previous settings, set each setting item all over again.

LANGUAGE CODE LIST

| No. | Language | Country code | No. | Language | Country code |
|-----|----------------|--------------|-----|-----------------|--------------|
| 1 | Afar | 4747 | 69 | Latvian;Lettish | 5868 |
| 2 | Abkhazian | 4748 | 70 | Malagasy | 5953 |
| 3 | Afrikaans | 4752 | 71 | Maori | 5955 |
| 4 | Amharic | 4759 | 72 | Macedonian | 5957 |
| 5 | Arabic | 4764 | 73 | Malayalam | 5958 |
| 6 | Assamese | 4765 | 74 | Mongolian | 5960 |
| 7 | Aymara | 4771 | 75 | Moldavian | 5961 |
| 8 | Azerbaijani | 4772 | 76 | Marathi | 5964 |
| 9 | Bashkir | 4847 | 77 | Malay | 5965 |
| 10 | Byelorussian | 4851 | 78 | Maltese | 5966 |
| 11 | Bulgarian | 4853 | 79 | Burmese | 5971 |
| 12 | Bihari | 4854 | 80 | Nauru | 6047 |
| 13 | Bislama | 4855 | 81 | Nepali | 6051 |
| 14 | Bengali;Bangla | 4860 | 82 | Dutch (DUT) | 6058 |
| 15 | Tibetan | 4861 | 83 | Norwegian | 6061 |
| 16 | Breton | 4864 | 84 | Occitan | 6149 |
| 17 | Catalan | 4947 | 85 | (Afan)Oromo | 6159 |
| 18 | Corsican | 4961 | 86 | Oriya | 6164 |
| 19 | Czech | 4965 | 87 | Panjabi | 6247 |
| 20 | Welsh | 4971 | 88 | Polish | 6258 |
| 21 | Danish | 5047 | 89 | Pashto;Pushto | 6265 |
| 22 | German (GER) | 5051 | 90 | Portuguese | 6266 |
| 23 | Bhutani | 5072 | 91 | Quechua | 6367 |
| 24 | Greek | 5158 | 92 | Rhaeto-Romance | 6459 |
| 25 | English (ENG) | 5160 | 93 | Kirundi | 6460 |
| 26 | Esperanto | 5161 | 94 | Romanian | 6461 |
| 27 | Spanish (SPA) | 5165 | 95 | Russian | 6467 |
| 28 | Estonian | 5166 | 96 | Kinyarwanda | 6469 |
| 29 | Basque | 5167 | 97 | Sanskrit | 6547 |
| 30 | Persian | 5247 | 98 | Sindhi | 6550 |
| 31 | Finnish | 5255 | 99 | Sangho | 6553 |
| 32 | Fiji | 5256 | 100 | Serbo-Croatian | 6554 |
| 33 | Faroese | 5261 | 101 | Singhalese | 6555 |
| 34 | French (FRE) | 5264 | 102 | Slovak | 6557 |
| 35 | Frisian | 5271 | 103 | Slovenian | 6558 |
| 36 | Irish | 5347 | 104 | Samoan | 6559 |
| 37 | Scots Gaelic | 5350 | 105 | Shona | 6560 |
| 38 | Galician | 5358 | 106 | Somali | 6561 |
| 39 | Guarani | 5360 | 107 | Albanian | 6563 |
| 40 | Gujarati | 5367 | 108 | Serbian | 6564 |
| 41 | Hausa | 5447 | 109 | Siswat | 6565 |
| 42 | Hindi | 5455 | 110 | Sesotho | 6566 |
| 43 | Croatian | 5464 | 111 | Sundanese | 6567 |
| 44 | Hungarian | 5467 | 112 | Swedish | 6568 |
| 45 | Armenian | 5471 | 113 | Swahili | 6569 |
| 46 | Interlingua | 5547 | 114 | Tamil | 6647 |
| 47 | Interlingue | 5551 | 115 | Telugu | 6652 |
| 48 | Inupiak | 5557 | 116 | Tajik | 6653 |
| 49 | Indonesian | 5560 | 117 | Thai | 6654 |
| 50 | Icelandic | 5565 | 118 | Tigrinya | 6655 |
| 51 | Italian (ITA) | 5566 | 119 | Turkmen | 6657 |
| 52 | Hebrew | 5569 | 120 | Tagalog | 6658 |
| 53 | Japanese (JPN) | 5647 | 121 | Setswana | 6660 |
| 54 | Yiddish | 5655 | 122 | Tonga | 6661 |
| 55 | Javanese | 5669 | 123 | Turkish | 6664 |
| 56 | Georgian | 5747 | 124 | Tsonga | 6665 |
| 57 | Kazakh | 5757 | 125 | Tatar | 6666 |
| 58 | Greenlandic | 5758 | 126 | Twi | 6669 |
| 59 | Cambodian | 5759 | 127 | Ukrainian | 6757 |
| 60 | Kannada | 5760 | 128 | Urdu | 6764 |
| 61 | Korean (KOR) | 5761 | 129 | Uzbek | 6772 |
| 62 | Kashmiri | 5765 | 130 | Vietnamese | 6855 |
| 63 | Kurdish | 5767 | 131 | Volapuk | 6861 |
| 64 | Kirghiz | 5771 | 132 | Wolof | 6961 |
| 65 | Latin | 5847 | 133 | Xhosa | 7054 |
| 66 | Lingala | 5860 | 134 | Yoruba | 7161 |
| 67 | Laothian | 5861 | 135 | Chinese (CHI) | 7254 |
| 68 | Lithuanian | 5866 | 136 | Zulu | 7267 |

TROUBLESHOOTING GUIDE

TV/VCR

Sometimes a performance problem can be easily solved by checking seemingly apparent but often overlooked possibilities. Before arranging for service, check these items. It could save your time and money.

| PROBLEM | CORRECTIVE ACTION |
|---|--|
| No power. | <ul style="list-style-type: none"> • Make sure the AC cord is connected to an AC outlet. • Make sure the power is turned on. |
| Remote Control Doesn't Work | <ul style="list-style-type: none"> • Is TV/DVD plugged in? • Power at outlet? • Check batteries in Remote Control. |
| No picture and sound. | <ul style="list-style-type: none"> • Make sure the AC cord is connected to an AC outlet. • Check antenna connection. • Let the TV/DVD/VHS program its tuner memory. |
| No picture or poor picture on TV/DVD/VHS. | <ul style="list-style-type: none"> • Adjust direction or replace antenna. • Adjust picture controls. |
| No sound or poor sound. | <ul style="list-style-type: none"> • Adjust volume control on remote control or main unit. • Press the MUTE button to restore sound. |
| Bars On Screen | <ul style="list-style-type: none"> • If outside antenna is being used, check for broken wire. • Check for local interference. |
| Picture Distorted or Blurred | <ul style="list-style-type: none"> • Try a new channel, if OK, then possible station trouble. • If outside antenna is being used, check for broken wire. |
| Picture Rolls Vertically Lines or Streaks in Picture | <ul style="list-style-type: none"> • Try a new channel, if OK, then possible station trouble. • If outside antenna is being used, check for broken wire. • Check for local interference. |
| No Color | <ul style="list-style-type: none"> • Try a new channel, if OK, then possible station trouble. • Is antenna connected to terminal on the back of the set? • If outside antenna is being used, check for broken wire. • Adjust COLOR control. |
| Poor Reception on Some Channels Ghosts in Picture | <ul style="list-style-type: none"> • Try a new channel, if OK, then possible station trouble. • Is antenna connected to terminal on the back of the set? • If outside antenna is being used, check for broken wire. • Check for local interference. |
| Weak Picture | <ul style="list-style-type: none"> • Try a new channel, if OK, then possible station trouble. • Is antenna connected to terminal on the back of the set? • If outside antenna is being used, check for broken wire. • Adjust CONTRAST & BRIGHT control. |
| Sound OK, Picture Poor | <ul style="list-style-type: none"> • Try a new channel, if OK, then possible station trouble. • Is antenna connected to terminal on the back of the set? • If outside antenna is being used, check for broken wire. • Check for local interference. • Adjust CONTRAST & BRIGHT control. |
| Picture OK, Sound Poor | <ul style="list-style-type: none"> • Try a new channel, if OK, then possible station trouble. • Check for local interference. |
| Timer recording is not possible. | <ul style="list-style-type: none"> • Make sure the timer recording is set correctly. • Make sure the power is off. • Make sure the TV/DVD/VHS clock is set correctly. |
| Cannot go into Record mode. | <ul style="list-style-type: none"> • Make sure the tape has an erase-prevention tab. If need, cover the hole with plastic tape. |

| PROBLEM | CORRECTIVE ACTION |
|---|---|
| Playback picture is partially noisy. | <ul style="list-style-type: none"> • Adjust tracking control for a better picture using the CHANNEL ▲ or ▼ button on the TV/DVD/VHS. |
| No picture but the audio is OK in playback. | <ul style="list-style-type: none"> • Head cleaning may be necessary. Refer to “AUTO HEAD CLEANING” on page 53. |
| No operation by infrared Remote Control. | <ul style="list-style-type: none"> • Make sure the AC cord is connected to an AC outlet. • Check batteries in remote control. |
| Video or color fades in and out when making a copy of a video tape. | <ul style="list-style-type: none"> • You can not copy a copyrighted video tape. You are experiencing copy guard protection. |
| Uneven color | <ul style="list-style-type: none"> • Unplug the AC cord for about 30 minutes, then plug it again. |

| CLOSED CAPTION PROBLEM | POSSIBLE REMEDY |
|--|--|
| My TV/DVD/VHS is showing captions that are misspelled. | <ul style="list-style-type: none"> • You are watching a live broadcast and spelling errors made by the closed captioning production company may pass through uncorrected. A prerecorded program will not show any misspelled words because of the normal time available for editing the captions. |
| My TV/DVD/VHS will not show the text dialogue in its entirety or there is a delay of what is being said. | <ul style="list-style-type: none"> • Captions that are delayed a few seconds behind the actual are common for live broadcast. Most captioning production companies can display a dialogue to a maximum of 220 words per minute. If a dialogue exceeds that rate, selective editing is used to insure that the captions remain up-to-date with the current TV screen dialogue. |
| My captions are scrambled with white boxes on the TV screen. | <ul style="list-style-type: none"> • Interference caused by building, power lines, thunderstorms, etc. may cause scrambled or incomplete captions to appear. |
| My program guide listed a TV show as being closed captioned but none of the captions were displayed. | <ul style="list-style-type: none"> • Broadcasters may at times use a time compression process to speed up the actual program so that additional advertising time can be given. Since the decoder cannot read the compressed information, captions will be lost. |
| My prerecorded video tape does not show any captions. The tape box mentions it being closed captioned. | <ul style="list-style-type: none"> • The video tape was either an illegal copy or the tape duplicating company accidentally left out the captioning signals during the copying process. |
| My TV screen shows a black box on certain channels. | <ul style="list-style-type: none"> • You are in the TEXT mode. Select CAPTION mode to CAPTION [OFF]. |

DVD

If the TV/DVD does not perform properly when operated as instructed in this Owner's Manual, check the player, consulting the following checklist.

| Symptom | Cause | Remedy |
|---|--|---|
| No power. | <ul style="list-style-type: none"> Loose power plug. | <ul style="list-style-type: none"> Insert the power plug firmly into the wall outlet. |
| The player does not respond to the remote control. | <ul style="list-style-type: none"> The remote control is not aimed at the sensor on the TV/DVD. Obstacles present between the remote control and the sensor. The remote control is too far away from the TV/DVD. Dead batteries. | <ul style="list-style-type: none"> Aim the remote control directly at the sensor on the TV/DVD. Remove the obstacles from the signal path. Use the remote control within 7m of the TV/DVD. Replace the batteries. |
| No picture | <ul style="list-style-type: none"> Loose video connection. Wrong disc. | <ul style="list-style-type: none"> Connect the video cables firmly. Insert a correct video disc that plays on this TV/DVD. |
| Disc cannot be played | <ul style="list-style-type: none"> No disc. Dirty disc. Disc is placed upside down. Parental lock is active. | <ul style="list-style-type: none"> Insert a disc. Clean the disc. Place the disc correctly, with the label side up. Cancel the parental lock or change the control level. |
| No sound | <ul style="list-style-type: none"> Loose audio connection. The power of the connected audio component is off. Wrong audio output settings. Wrong input settings on the connected audio component. | <ul style="list-style-type: none"> Connect the audio cables firmly. Turn the power of the audio component on. Correct the audio output settings. Correct the input settings on the audio component. |
| Distorted picture | <ul style="list-style-type: none"> Immediately after playing, press fast forward or in reverse. | <ul style="list-style-type: none"> There are some cases where pictures may be slightly distorted, which are not a sign of a malfunction. |
| Audio or subtitle language does not match the setup. | <ul style="list-style-type: none"> The selected language is not available for audio or subtitles on the DVD. | <ul style="list-style-type: none"> No malfunction. |
| The camera angle cannot be changed. | <ul style="list-style-type: none"> The DVD does not contain sequences recorded from different camera angles. | <ul style="list-style-type: none"> No malfunction. |
| Audio or subtitle language cannot be changed. | <ul style="list-style-type: none"> The DVD does not contain audio source or subtitles in the selected language. | <ul style="list-style-type: none"> No malfunction. |
| "Prohibited icon" appears on the screen, prohibiting an operation. | <ul style="list-style-type: none"> That operation is prohibited by the TV/DVD or disc. | <ul style="list-style-type: none"> No malfunction. |
| CD sound dropout No CD reproduction DVD picture dropout DVD picture freeze DVD picture in mosaic No DVD reproduction | <ul style="list-style-type: none"> Scratched disc | <ul style="list-style-type: none"> Replace the disc with unscratched one. |

NOTES:

- Some functions are not available in specific modes, but this is not a malfunction. Read the description in this Owner's Manual for details on correct operations.
- Playback from a desired track and random playback are not available during program playback.

MAINTENANCE

CABINET CLEANING

- Wipe the front panel and other exterior surfaces of the TV/DVD with a soft cloth immersed in luke-warm water and wrung dry.
- Never use a solvent or alcohol. Do not spray insecticide liquid near the TV/DVD. Such chemicals may cause damage and discoloration to the exposed surfaces.

AUTO HEAD CLEANING

- Automatically cleans video heads as you insert or remove a cassette, so you can see a clear picture.
- Playback picture may become blurred or interrupted while the TV program reception is clear. Dirt accumulated on the video heads after long periods of use, or the usage of rental or worn tapes can cause this problem.

If a streaky or snowy picture appears during playback, the video heads in your TV/DVD/VHS may need to be cleaned.

IF THE LASER OPTICAL PICKUP UNIT IS DIRTY

- If the player still does not perform properly when it is operated while referring to the relevant sections and to "TROUBLESHOOTING GUIDE" in this Owner's Manual, the laser optical pickup unit may be dirty. Consult your dealer or an Authorized Service Center for inspection and cleaning of the laser optical pickup unit.

1. Please visit your local Audio/Video store and purchase a good quality VHS Video Head Cleaner.
2. If a Video Head Cleaner does not solve the problem, please call our help line at 1-800-968-3429, to locate an Authorized Service Center.

NOTES:

- Remember to read the instructions included with the video head cleaner before use.
- Clean video heads only when problems occur.

SERVICING

- Should your TV/DVD become inoperative, do not try to correct the problem by yourself. There are no user-serviceable parts inside. Turn off, unplug the power cord, and please call our help line at 1-800-968-3429, to locate an Authorized Service Center.

DISC HANDLING

- Use discs which have the following logos on them. (Optical audio digital discs.)



- Handle the discs so that fingerprints and dust do not adhere to the surfaces of the discs.
- Always store the disc in its protective case when it is not used.

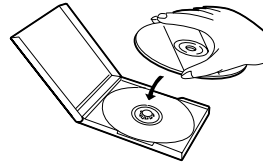
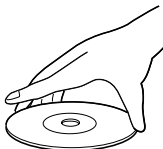
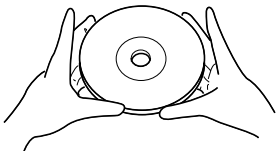

- To clean-off, use a soft cloth.
- Do not use a hard cloth since this will mar the disc.
- Wipe the disc in a straight line from center to edge.
- Never wipe with a circular motion.
- Do not use detergent or abrasive cleaning agents.

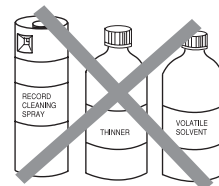
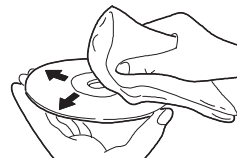

SPECIFICATIONS

GENERAL SPECIFICATIONS

TV/VCR

| | |
|-------------------------|--|
| CRT : | 19 inch in-line gun, 90° deflection tube |
| Television system : | NTSC-M |
| Closed caption system : | §15.119/FCC |
| Video Heads : | Rotary four-head |
| Tape width : | 1/2 inch |
| Tape speed | |
| SP : | 33.40mm/sec. |
| LP : | 16.67mm/sec. |
| SLP : | 11.12mm/sec. |
| Tuner channel | |
| TV VHF Low : | #2~#6 |
| TV VHF High : | #7~#13 |
| TV UHF : | #14~#69 |
| CATV | |
| VHF : | 5A |
| MID band : | A5~A1, A~I |
| SUPER band : | J~W |
| HYPER band : | W+1~W+84 |

DVD

| | |
|---|--|
| Product type: | DVD Player |
| Discs: | DVD video, Audio CD |
| Output signal format: | NTSC color |
| Frequency response (out put jack) | |
| DVD (linear sound): | 20 Hz to 22 kHz (sample rate: 48 kHz) 20 Hz to 44 kHz (sample rate: 96 kHz) |
| CD: | 20 Hz to 20 kHz |
| Signal-to-noise ratio (S/N ratio)(out put jack) | |
| CD: | 100 dB (EIAJ) |
| Dynamic range (out put jack) | |
| DVD (linear sound): | 85 dB |
| CD: | 84 dB (EIAJ) |
| Total distortion factor | |
| CD: | 0.07% (EIAJ) |
| Wow and flutter: | Below the measurement limitation (+/-0.001% W PEAK) (EIAJ) |

ELECTRICAL SPECIFICATIONS

Sound output: 2 speakers, 1W, 8 ohm

OTHER SPECIFICATIONS

| | |
|-------------------------------|---|
| Terminals | |
| Antenna input: | VHF/UHF/CATV 75 ohm unbalanced (F-type) |
| Video input: | RCA connector × 1 |
| Audio L/R input: | RCA connector × 2 |
| Headphone: | 1/8" stereo (3.5 mm) |
| Coaxial digital audio output: | One pin jack, 500m Vpp (75 ohm) |
| Analog audio L/R output : | RCA connector × 2 |
| Remote control: | Digital encoded infrared light system |
| Operating temperature: | 5°C to 40°C (41°F~104°F) |
| Power requirements: | AC 120V, 60Hz |
| Power consumption (Maximum): | 85W |
| Picture tube: | 19" |
| Dimensions: | H:19-21/32" (500mm) W:23-13/16" (605mm) D:18-11/16" (475mm) |
| Weight: | 48.5 lbs (22kg) |
| Accessories: | Remote Control Unit with 2"AA"batteries Owner's Manual |

- Designs and specifications are subject to change without notice and without our legal obligation.
- If there is a discrepancy between languages, the default language will be English.

MEMO

INDICE

| | |
|---|----|
| ■ CONTROLES DE OPERACIÓN Y FUNCIONES | 56 |
| PANEL FRONTAL DEL televisor/DVD/VHS | 56 |
| MANDO A DISTANCIA | 56 |
| VISTA POSTERIOR | 56 |
| ■ PREPARACIÓN PARA LA UTILIZACIÓN | 58 |
| CONEXIONES DE ANTENA/TELEVISIÓN | |
| POR CABLE | 58 |
| INSTALACIÓN DE LAS PILAS | 58 |
| CONEXIÓN A TOMAS DE ENTRADA EXTERNA | 58 |
| MODE DE ENTRADA EXTERNA | 58 |
| CONEXIÓN A UN SISTEMA ESTÉREO (Para DVD) | 58 |
| CONEXIÓN A UN AMPLIFICADOR EQUIPADO CON | |
| TOMAS DE ENTRADA DIGITAL, PLATINA MD O | |
| PLATINA DAT (Para DVD) | 58 |
| CONEXIÓN A UN DECODIFICADOR DOLBY DIGITAL | |
| O A UN DECODIFICADOR DTS (Para DVD) | 59 |
| TV SECTION | |
| ■ PREPARACIÓN PARA LA UTILIZACIÓN | 60 |
| SELECCIÓN DE IDIOMA | 60 |
| PREAJUSTE DE CANALES | 60 |
| DVD SECTION | |
| ■ REPRODUCCIÓN DE UN DISCO | 61 |
| REPRODUCCIÓN DE UN DVD DE VÍDEO O UN CD DE | |
| AUDIO | 61 |

CONTROLES DE OPERACIÓN Y FUNCIONES

PANEL FRONTAL DEL TELEVISOR/DVD

Consulte la figura 1 de la página 9

MANDO A DISTANCIA

Consulte la figura 2 de la página 9

VISTA POSTERIOR

Consulte la figura 3 de la página 10

- 1. Botón POWER**
Púlselo para conectar y desconectar la alimentación.
- 2. Botones VOLUME ▲/▼**
Púlselos para controlar el nivel del volumen para el DVD y el televisor.
- 3. Botones SKIP (para DVD)**
Salta capítulos o pistas hasta un punto deseado.
- 4. Botón PLAY**
Inicia la reproducción del contenido del disco o la cinta.
- 5. Botón STOP**
Detiene la operación del disco o la cinta.
- 6. Botón OPEN/CLOSE**
Púlselo para insertar discos en la bandeja o

retirarlos de ella.

- 7. Bandeja de carga del disco**
- 8. Indicador de DVD**
Parpadea durante el modo del DVD.
- 9. Botón SELECT**
Púlselo para cambiar a un modo de televisor, modo de entrada externa o modo de DVD.
- 10. Indicador del televisor/ la videograbadora (TV/VCR)**
Parpadea durante el modo del televisor/ la videograbadora
- 11. Botones CHANNEL ▲/▼**
Púlselo para seleccionar el canal memorizado.
Púlselo para cambiar a un modo de televisor cuando modo de DVD.
- 12. Indicador de grabación (RECORD)**
Parpadea durante la grabación.
Se enciende en el modo de espera de la grabación con temporizador.
Botón de grabación de un toque (OTR)
Activa la grabación de un toque. (Sólo en el televisor/DVD/VHS)
- 13. Botón de grabación (REC)**
Púlselo para iniciar la grabación manual.
- 14. Botón de rebobinado (REW) (para televisor/ videograbadora)**
Púlselo para rebobinar la cinta, o para ver la imagen en retroceso rápido durante el modo de reproducción. (Búsqueda con rebobinado)
- 15. Botón de avance rápido (FWD) (para televisor/ videograbadora)**
Púlselo para avanzar rápidamente la cinta, o para ver la imagen en avance rápido durante el modo de reproducción. (Búsqueda con avance rápido)
- 16. Botón de parada (STOP)**
Púlselo para detener la cinta.
Botón de expulsión (EJECT)
Púlselo en el modo de parada para expulsar la cinta del televisor/videograbadora.
- 17. Ventanilla del sensor del mando a distancia**
- 18. Toma HEADPHONE**
Para conectar auriculares (no suministrados) y escuchar en privado.
- 19. Toma de entrada VIDEO**
Conecte aquí la toma de salida de vídeo de una videocámara o de una videograbadora.
- 20. Tomas de entrada AUDIO L/R**
Conecte aquí las tomas de salida de audio de una videocámara o de una videograbadora.
- 21. Compartimiento del videocasete**
- 22. Botón PICTURE**
Presione para entrar en el modo de ajuste de imagen.

23. Botones de números

Modo del televisor:

Pulse dos dígitos para tener acceso directamente al canal deseado.

Recuerde pulsar "0" antes de elegir un canal de un solo dígito.

Botón +100

Púselo para seleccionar canales de televisión por cable cuyo número sea igual o superior al 100.

Modo DVD:

Púselo para introducir el número deseado.

Botón +10

Púselo para introducir los números deseados cuyo número sea igual o superior al 10.

24. Botón PAUSE

Hace una pausa en la operación del disco o la cinta.

25. Botón de velocidad de cinta (SPEED)

Púselo para elegir la velocidad de grabación deseada: SP/SLP.

26. Botón C-RESET

Púselo para reponer el contador a 0:00:00.

27. Botón DISPLAY

Modo del televisor/ la videograbadora:

Púselo para visualizar el número del canal en la pantalla. Si lo pulsa de nuevo, el número del canal desaparecerá.

Modo de DVD:

Visualiza el estado actual en la pantalla del televisor con fines de comprobación.

28. Botón SETUP

Púselo para activar o salir del modo de menús de televisor o preparación de DVD.

29. Botón TITLE

Visualiza el menú de títulos.

30. Botón CLEAR

Repone un ajuste.

31. Botón MODE

Activa el modo de reproducción programada o el modo de reproducción aleatoria.

32. Botón SEARCH MODE

Púselo para localizar un punto deseado.

33. Botón AUDIO

Púselo para seleccionar un idioma de audio o un modo de sonido deseado.

34. Botón SUBTITLE

Púselo para seleccionar un idioma de subtítulos deseado.

35. Botón REPEAT

Repite la reproducción del disco, título, capítulo o pista actual.

36. Botón ANGLE

Púselo para cambiar el ángulo de la cámara y verde, desde un ángulo diferente, la secuencia que está siendo reproducida.

37. Botón A-B REPEAT

Repite la reproducción de una sección seleccionada.

38. Botón RETURN

Para volver a la operación anterior.

39. Botón ENTER

Púselo para establecer un ajuste.

40. Botones de flechas

Modo de televisor:

Púselo para seleccionar un modo de ajuste desde el menú que aparece en la pantalla del televisor.

Púselo para seleccionar o ajustar desde un menú particular.

Modo de DVD:

Se utiliza cuando se hacen ajustes mientras se observa la visualización en una pantalla de televisor.

41. Botón DISC MENU

Visualiza menús de DVD.

42. Botón ZOOM

Amplia parte de una imagen de DVD reproducida.

43. Botón MUTE

Pulse el botón MUTE para apagar el sonido de un programa de TV. La visualización del nivel del sonido cambia de ROJO CLARO a AZUL CLARO.) Pulse de nuevo el botón MUTE o el botón VOL ▲ o ▼ para restaurar el sonido.

44. Botón DVD

Púselo para cambiar a un modo de DVD.

45. Botón TV/VCR

Púselo para cambiar a un modo de televisor/ videograbadora.

46. Toma de entrada ANT.

Conéctela a una antena, sistema de televisión por cable o sistema de satélite.

47. Cable de alimentación

Conéctelo a una toma de CA convencional (120 V/60 Hz).

NOTA: Retire el cable de alimentación del gancho para evitar romperlo antes de conectarlo a una toma de CA convencional.

48. Toma de salida de audio digital COAXIAL

Conéctela a la entrada digital de un amplificador o decodificador externo.

49. Toma de salida AUDIO L/R

Conéctela a la entrada de audio analógico de un amplificador o decodificador externo.

NOTA: Las tomas de entrada de audio (rojo y blanca) en el lado trasero sirven para producir no el son televisor ni el son de entrada externa, sino el son DVD.

PREPARACIÓN PARA LA UTILIZACIÓN

CONEXIONES DE ANTENA/TELEVISIÓN POR CABLE

Consulte la figura 4 de la página 11

ANTENAS SEPARADAS DE VHF/UHF

En algunas áreas será necesario utilizar una antena exterior.

Consulte la figura 4 de la página 11

TELEVISIÓN POR CABLE SIN CAJA DE CONVERTIDOR/DECODIFICADOR

Utilice esta conexión si su sistema de televisión por cable se conecta directamente a su televisor/DVD/VHS sin necesidad de caja de convertidor.

Consulte la figura 4 de la página 11

TELEVISIÓN POR CABLE CON CAJA DE CONVERTIDOR/DECODIFICADOR O CAJA DE SATÉLITE

Si su proveedor de servicios de televisión por cable le suministra una caja de convertidor o si usted utiliza un sistema de satélite, podrá utilizar la conexión básica mostrada aquí.

Consulte la figura 4 de la página 11

INSTALACIÓN DE LAS PILAS

- 1) Abra la tapa del compartimiento de las pilas del mando a distancia presionándola en el sentido de la flecha.
- 2) Inserte 2 pilas tamaño "AA" en su compartimiento colocando las polaridades (+/-) en sus posiciones correspondientes.
- 3) Vuelva a poner la tapa.

CONEXIÓN A TOMAS DE ENTRADA EXTERNA

Cuando vea un programa grabado en otra fuente (videograbadora o videocámara), utilice las tomas de entrada de audio/vídeo de la parte delantera del televisor/DVD/VHS.

Conecte las tomas de salida de audio/vídeo de otra

fente a las tomas AUDIO L/R y VIDEO de este televisor/DVD/VHS. Y luego pulse el botón SELECT hasta que "VIDEO" aparezca en la pantalla.

NOTA:

- Cuando conecte una videograbadora monoaural (otra fuente) a este televisor/DVD/VHS, conecte la toma de salida de audio de la videograbadora monoaural (otra fuente) a la toma AUDIO L de este televisor/DVD/VHS. El audio saldrá igualmente en los canales L y R.

Consulte la figura 5 de la página 12

Conexiones de antena/televisión por cable
Continúa en la página siguiente.

MODO DE ENTRADA EXTERNA

Cuando utilice una señal de entrada externa (otra videograbadora o una videocámara), conecte los cables de salida de audio/vídeo del equipo de reproducción a las tomas AUDIO IN/VIDEO IN de su televisor/videograbadora. Y luego pulse el botón CHANNEL ▲ o ▼ hasta que "AUX" aparezca en la pantalla.

Usted puede programar el temporizador para que explore todos los canales que puedan recibirse en su zona.

CONEXIÓN A UN SISTEMA ESTÉREO (Para DVD)

Consulte la figura 6 de la página 14

NOTAS:

- Asegúrese de desconectar la alimentación a todos los componentes del sistema antes de hacer la conexión a otro componente.
- Consulte el manual del propietario de su sistema estéreo y de cualquier otro componente que vaya a conectar al televisor/DVD/VHS.
- Las tomas de entrada de audio (roja y blanca) en el lado trasero sirven para producir no el son televisor ni el son de entrada externa, sino el son DVD.

CONEXIÓN A UN AMPLIFICADOR EQUIPADO CON TOMAS DE ENTRADA DIGITAL, PLATINA MD O PLATINA DAT (Para DVD)

Utilice un cable digital coaxial (de venta en el comercio) para las conexiones de audio.

Consulte la figura 7 de la página 14

NOTAS:

- La fuente de audio de un disco del formato de sonido ambiental Dolby Digital de 5,1 canales no puede ser grabada como sonido digital por una platina MD o DAT.
 - Asegúrese de desconectar la alimentación de todos los componentes del sistema antes de hacer la conexión a otro componente.
 - Consulte los manuales del propietario de los componentes que vaya a conectar al televisor/DVD/VHS.
 - Ponga DOLBY DIGITAL y DTS en OFF para la salida de audio en el modo de preparación. La reproducción en el televisor/DVD/VHS utilizando los ajustes incorrectos puede generar distorsión de ruido, y también puede estropear los altavoces.
 - El audio se silenciará cuando DOLBY DIGITAL se ponga en OFF y VIRTUAL 3D se ponga en ON para la salida de audio en el modo de preparación y usted seleccione la fuente de audio del formato de sonido ambiental Dolby Digital de 5,1 canales.
- A menos que se haga la conexión a un decodificador Dolby Digital o DTS, ponga DOLBY DIGITAL y DTS en OFF para la salida de audio en el modo de preparación. La reproducción en el televisor/DVD/VHS utilizando los ajustes incorrectos puede generar distorsión de ruido, y también puede estropear los altavoces.
 - El audio se silenciará cuando DOLBY DIGITAL se ponga en OFF y VIRTUAL 3D se ponga en ON para la salida de audio en el modo de preparación y usted seleccione la fuente de audio del formato de sonido ambiental Dolby Digital de 5,1 canales.

CONEXIÓN A UN DECODIFICADOR DOLBY DIGITAL O A UN DECODIFICADOR DTS (Para DVD)

Si se utiliza este televisor/DVD/VHS para reproducir fuentes del formato de sonido ambiental Dolby Digital de 5,1 canales o de sonido ambiental DTS, el televisor/DVD/VHS dará salida a un flujo de datos Dolby Digital o DTS desde su toma de salida de audio digital COAXIAL. Conectando el reproductor a un decodificador Dolby Digital o DTS, usted podrá disfrutar de un ambiente más convincente y real con un sonido ambiental potente y de alta calidad de tipo profesional tal como el que se oye en salas de cine. Utilice cables digitales coaxiales (de venta en el comercio) para las conexiones de audio.

Consulte la figura 8 de la página 13

NOTAS:

- Asegúrese de desconectar la alimentación de todos los componentes del sistema antes de hacer la conexión a otro componente.
- Consulte los manuales del propietario de los componentes que vaya a conectar al televisor/DVD/VHS.
- Si conecta un decodificador Dolby Digital, ponga DOLBY DIGITAL en ON para la salida de audio en el modo de preparación.
- Si conecta un decodificador DTS, ponga DTS en ON para la salida de audio en el modo de preparación.

Fabricado bajo licencia de Dolby Laboratories. “Dolby” y el símbolo de la D doble son marcas de fábrica de Dolby Laboratories.

“DTS” y “DTS Digital Out” son marcas de fábrica de Digital Theater Systems, Inc.

PREPARACIÓN PARA LA UTILIZACIÓN

PREPARACIÓN DE CANALES POR PRIMERA VEZ

1

Conecte el cable de alimentación a una toma de CA convencional.

NOTA: Si aparecen algunos dígitos en la esquina de la pantalla, pulse el botón POWER sin desenchufar el cable de alimentación.

2

Pulse el botón POWER para encender el televisor/DVD/VHS.

3

Seleccione "ESPAÑOL" o "ENGLISH" (inglés), "FRANÇAIS" (francés) utilizando el botón de flecha ► o ◀.

4

Pulse el botón flecha ▲ o ▼ para señalar "AUTOPRESELECCION".

Luego pulse el botón flecha ►. El sintonizador explorará y memorizará todos los canales activos de su área.

NOTAS:

- El televisor/videgrabadora distingue entre los canales de televisión estándar y los canales de televisor por cable.
- Si desea reproducir o grabar una cinta ANTES de preajustar el sintonizador, usted tendrá que pulsar el botón SETUP en el mando a distancia. Para preajustar de nuevo el sintonizador, consulte "REPETICIÓN DE LA PREPARACIÓN DE CANALES".
- La unidad de televisor/videgrabadora puede reconocer los canales de TV como ellos de TV por cable a causa de los condiciones de recepción. En este caso, pruebe el preajuste automático de nuevo en los condiciones finas de recepción.

5

El sintonizador se para en el canal memorizado más bajo. Si desea recuperar canales seleccionados, usted podrá seleccionar directamente el canal deseado con los botones numerados del mando a distancia o con los botones CHANNEL ▲ o ▼.

Cerciórese...

• La alimentación del televisor/videgrabadora deberá estar conectada.

En el ejemplo de abajo, el reloj va a ajustarse así:

FECHA: 7 de mayo de 2002

HORA: 5:40 PM

1

Pulse el botón SETUP en el mando a distancia.

Pulse el botón PLAY/▲ o STOP/▼ para indicar "AJUSTE RELOJ". Luego, pulse el botón F.FWD/►.

2

Pulse el botón PLAY/▲ o STOP/▼ para indicar "AJUSTE MANUAL RELOJ". Luego, pulse el botón F.FWD/►.

3

Pulse el botón PLAY/▲ o STOP/▼ hasta que aparezca el mes deseado. (Ejemplo: Mayo - 05) Luego, pulse el botón F.FWD/►.

4

Pulse el botón PLAY/▲ o STOP/▼ hasta que aparezca el día del mes deseado. (Ejemplo: 7 - 07) Luego, pulse el botón F.FWD/►.

5

Pulse el botón PLAY/▲ o STOP/▼ hasta que aparezca el año deseado. (Ejemplo: 2002) Luego, pulse el botón F.FWD/►.

6

Pulse el botón PLAY/▲ o STOP/▼ hasta que aparezca la hora deseada. (Ejemplo: 5, PM) Luego, pulse el botón F.FWD/►.

7

Pulse el botón PLAY/▲ o STOP/▼ hasta que aparezca el minuto deseado. (Ejemplo: 40)

8

Pulse el botón SRTUP en el mando a distancia.

Aunque los segundos no se visualizan, éstos empiezan a contar desde 00 cuando se pulsa SETUP en el mando a distancia. Utilice esta función para sincronizar el reloj con la hora correcta.

DVD SECTION

REPRODUCCIÓN DE UN DISCO

REPRODUCCIÓN DE UN DVD DE VÍDEO O UN CD DE AUDIO

DVD

CD

Para empezar

Conecte la alimentación del televisor, amplificador y cualquier otro componente que esté conectado al reproductor DVD. (Cambie el sistema de entrada para adaptarlo al reproductor DVD, y compruebe que el volumen del sonido sea correcto.)

1 Pulse el botón POWER.

- La alimentación se conectará.

2 Pulse el botón OPEN/CLOSE.

- La bandeja de carga del disco se abrirá.

3 Ponga un disco en la bandeja.

- Asegúrese de que el disco esté correctamente asentado en el hueco correcto, con el lado de la etiqueta hacia arriba.

4 Pulse el botón PLAY.

- La bandeja se cerrará automáticamente y la reproducción empezará desde el primer capítulo o pista del disco. Necesitará pulsar el botón PLAY sólo cuando la bandeja haya sido cerrada pulsando el botón OPEN/CLOSE.
- Cuando reproduzca un DVD que tenga grabado un menú de títulos, el menú tal vez aparezca en la pantalla. En este caso, consulte "UTILIZACIÓN DEL MENÚ DE TÍTULOS".

5 Pulse el botón STOP para detener la reproducción.

MEMO

MEMO

SYLVANIA

LIMITED WARRANTY

FUNAI CORP. will repair this SYLVANIA product, free of charge in the USA in the event of defect in materials or workmanship as follows:

DURATION:

PARTS: FUNAI CORP. will provide parts to replace defective parts without charge for one (1) year from the date of original retail purchase. Two (2) years for Picture Tube. Certain parts are excluded from this warranty.

LABOR: FUNAI CORP. will provide the labor without charge for a period of ninety (90) days from the date of original retail purchase.

LIMITS AND EXCLUSIONS:

This warranty is extended only to the original retail purchaser. A purchase receipt or other proof of original retail purchase will be required together with the product to obtain service under this warranty.

This warranty shall not be extended to any other person or transferee.

This warranty is void and of no effect if any serial numbers on the product are altered, replaced, defaced, missing or if service was attempted by an unauthorized service center. This SYLVANIA Limited warranty does not apply to any product not purchased and used in the United States.

This warranty only covers failures due to defects in material or workmanship which occurs during normal use. It does not cover damage which occurs in shipment, or failures which are caused by repairs, alterations or product not supplied by FUNAI CORP., or damage which results from accident, misuse, abuse, mishandling, misapplication, alteration, faulty installation, improper maintenance, commercial use such as hotel, rental or office use of this product or damage which results from fire, flood, lightning or other acts of God.

THIS WARRANTY DOES NOT COVER PACKING MATERIALS, ANY ACCESSORIES (EXCEPT REMOTE CONTROL), ANY COSMETIC PARTS, COMPLETE ASSEMBLY PARTS, DEMO OR FLOOR MODELS.

FUNAI CORP. AND ITS REPRESENTATIVES OR AGENTS SHALL IN NO EVENT BE LIABLE FOR ANY GENERAL, INDIRECT OR CONSEQUENTIAL DAMAGES ARISING OUT OF OR OCCASIONED BY THE USE OF OR THE INABILITY TO USE THIS PRODUCT. THIS WARRANTY IS MADE IN LIEU OF ALL OTHER WARRANTIES, EXPRESS OR IMPLIED, AND OF ALL OTHER LIABILITIES ON THE PART OF FUNAI. ALL OTHER WARRANTIES INCLUDING THE WARRANTY OF MERCHANTABILITY, AND FITNESS FOR A PARTICULAR PURPOSE, ARE HEREBY DISCLAIMED BY FUNAI AND ITS REPRESENTATIVES IN THE UNITED STATES.

ALL WARRANTY INSPECTIONS AND REPAIRS MUST BE PERFORMED BY A FUNAI AUTHORIZED SERVICE CENTER. THIS WARRANTY IS VALID WHEN THE UNIT IS CARRIED-IN TO FUNAI AUTHORIZED SERVICE FACILITY.

IMPORTANT:

THIS LIMITED WARRANTY GIVES YOU SPECIFIC LEGAL RIGHTS, YOU MAY HAVE OTHER RIGHTS THAT VARY FROM STATE TO STATE, IF, AT ANY TIME DURING THE WARRANTY PERIOD, YOU ARE UNABLE TO OBTAIN SATISFACTION WITH THE REPAIR OF THIS PRODUCT, PLEASE CONTACT FUNAI CORP.

ATTENTION:

FUNAI CORP. RESERVES THE RIGHT TO MODIFY ANY DESIGN OF THIS PRODUCT WITHOUT PRIOR NOTICE.

To locate your nearest SYLVANIA Authorized Service Center or for general service procedure, please call 1-800-968-3429 or write to the following:

FUNAI CORPORATION, INC.

Customer Service

100 North Street; Teterboro, NJ 07608

Tel :1-800-968-3429

PLEASE DO NOT SHIP YOUR UNIT TO THE TETERBORO ADDRESS.